



Leadshine

Stock Code: 002979



CODESYS



EtherNet/IP™

EtherCAT®

MC500 series

General Type EtherCAT Bus PLC

Stable Efficient Easy to use

In industries such as photovoltaic, semiconductor, electronics, CNC and logistics, alongside the upcoming of China's Intelligence Manufacturing 2025, there is a need to improve equipment efficiency and ease-of-use, as well as cost reduction. We need to find a more user-friendly, expandable and highly integrated control solution to achieve efficient operation throughout the

entire installation process from wiring, programming, debugging and application. Leadshine has launched a new economical bus type controller MC500 series to meet the increasingly high demands of motion control. MC500 series controller has a more complete functionalities for smart devices connection applications.

- Balancing motion control, complete functionality, and intelligent connectivity greatly
- Reduces user device development time, improving efficiency by 30% compared to traditional development models

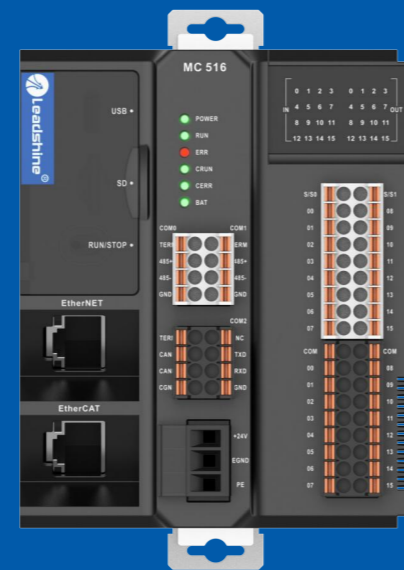

Features

Motion control

- EtherCAT 32 axes
- 200kHz high-speed pulse 6 axes
- 6 axes linear / 3 axes circular interpolation
- E-CAM/flying shear/chasing shear

Intelligent interconnection

- OPC UA
- EtherNET/IP
- 32 CANopen distributed control
- Modbus/Free communication port

Rich functionality

- local bus expand 32 I/O modules
- 32767 I/O
- 6 200kHz high-speed counting
- over temperature, over voltage, short circuit protection

Motion control 6 high-speed pulse axes + 32 EtherCAT axes

The excellent performance of a dual core SOC+FPGA high-speed processor enables motion control functions such as positioning, interpolation, and E-CAM that comply with PLCopen standards.

Interpolation

Multidimensional linear interpolation, circular interpolation, and continuous interpolation can be used to control the trajectory for machining with certain precision and high-speed positioning transmission according to the shortest route.

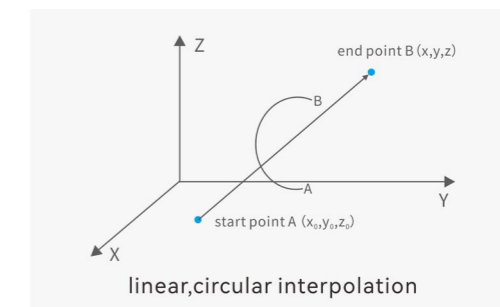

E-CAM

By digitizing cam movements, the problems of low precision, easy wear and noise in mechanical cams can be solved.

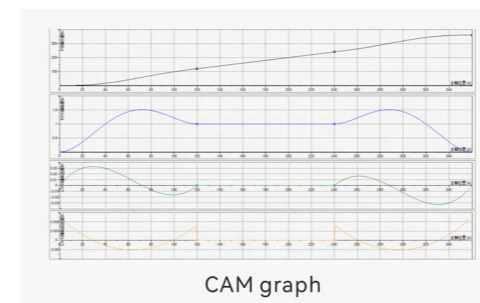

Flying Shear

By setting values such as cutting length, number of cutting heads, and synchronization zone through process parameters, a rotary cutting cam table can be established within the synchronization zone, with the spindle and slave shafts operating at a certain speed ratio.

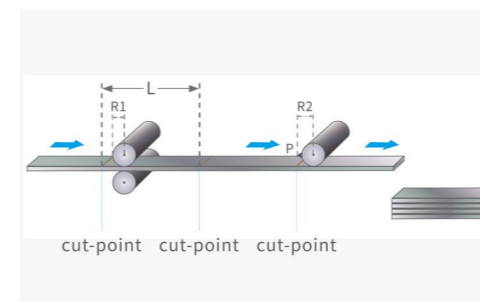

Chasing Shear

By setting values such as cutting length, waiting position, chasing area, synchronization area, and return area through process parameters, a chasing cam table can be established, which is suitable for application scenarios such as cutting and filling.

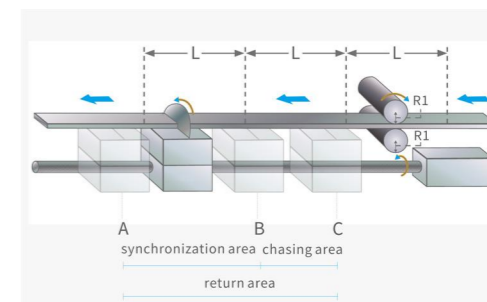

PLC
digital module
analog module
temperature module
encoder module

Program

- Type-C port
- upload or download program

Save

- Optional SD card
- download program ,save data

Serial port

- 2*RS485,1*RS232
- Integrated serial port adapted instrument connection

Ethernet OPC UA EtherNet/IP

- OPC UA,EtherNet/IP
- Modbus-TCP,Socket

Motion control EtherCAT

- maximum control 32 axes
- Configure up to 128 EtherCAT slaves

Distributed CANopen

- The farthest transmission distance : 2.5km
- Configure up to 31 CANopen slaves

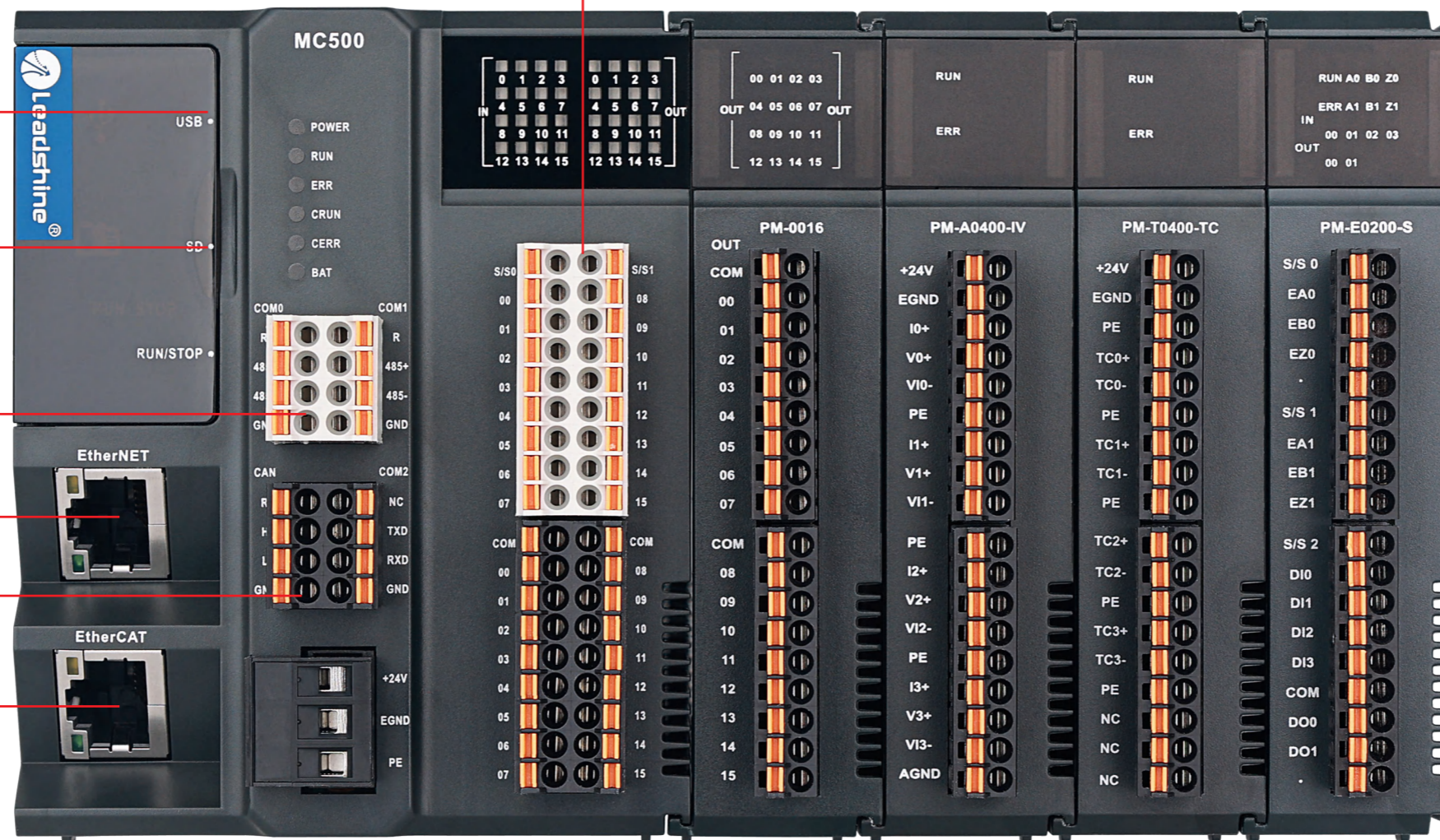

I/O

- integrated 32 IO(16 inputs 16 outputs)
- 6*200kHz high-speed pulse
- output6*200kHz high-speed counting

100M high-speed internal backplane bus,maximum expanding 32 I/O modules

- CPU: Dual core high-speed processor
- I/O,motion control synchronous time:1ms
- synchronous jitter time:1μs
- processing speed: 10ns
- program capacity:20MB
- data capacity: 40MB
- Power-Failure Retention Area:512KB

Application
 photovoltaic, Lithium battery, semiconductor, 3C, Logistics industry, packing, Special machine tool industry ect.



Robot
Industrial camera
Servo
Stepper
R2 series i/o module

Intelligent interconnection

OPC UA is an open international standard communication protocol. It is an industrial communication specification for intelligent manufacturing. It can directly and securely connect with IT systems such as MES/ERP to achieve tamper proof data, strengthen secure transmission, and eliminate interoperability barriers between the Mechanical floor and the information layer, helping traditional enterprises to achieve lean production in factories.

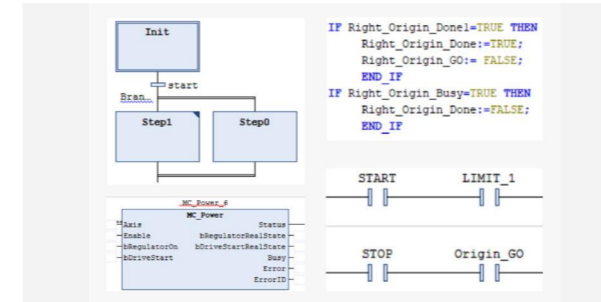
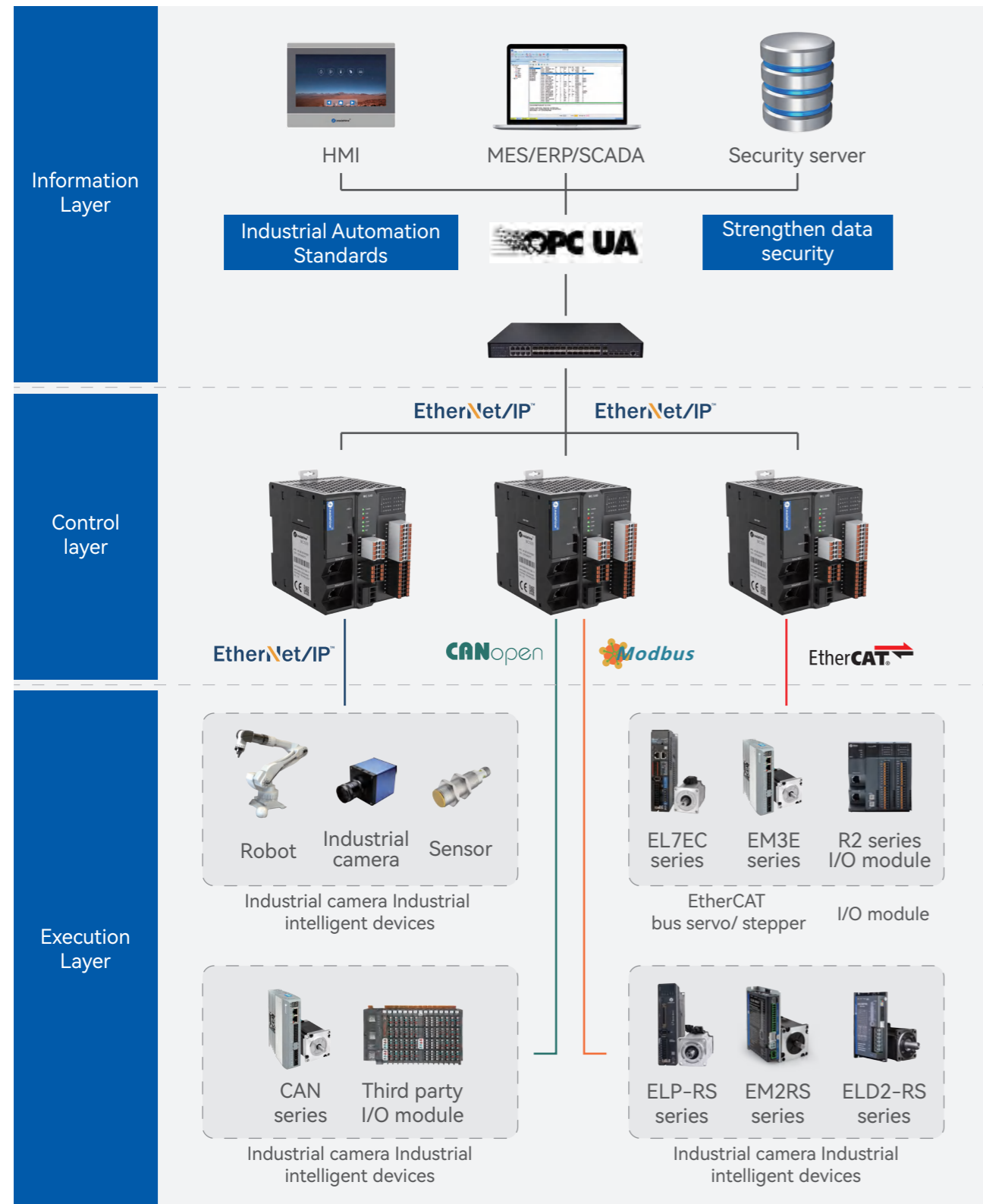

Program language :ST,LD,CFC,SFC,FB,IL

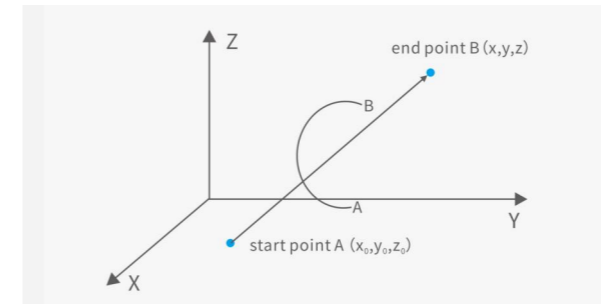

Space Interpolation

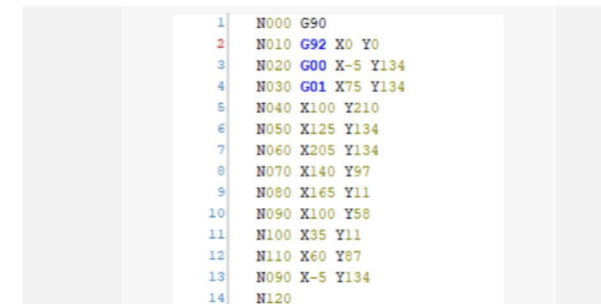

G code

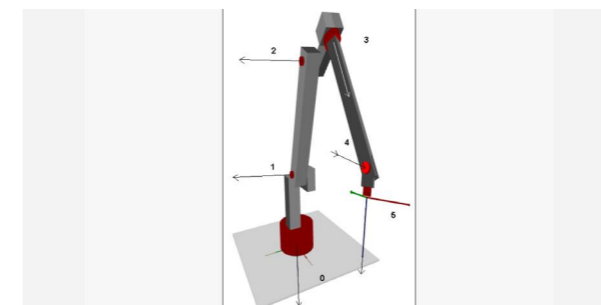

Robot



Online simulation

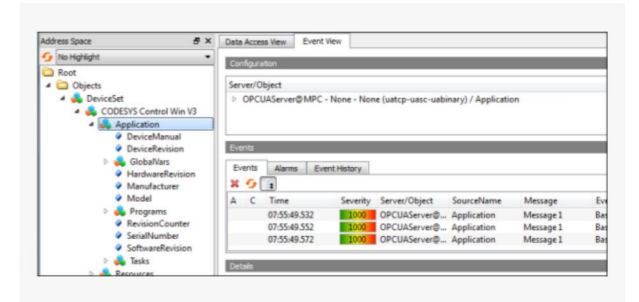

OPC_UA informationize function



E-CAM

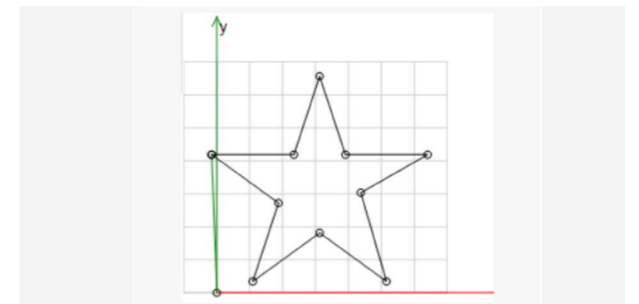

CNC tool path

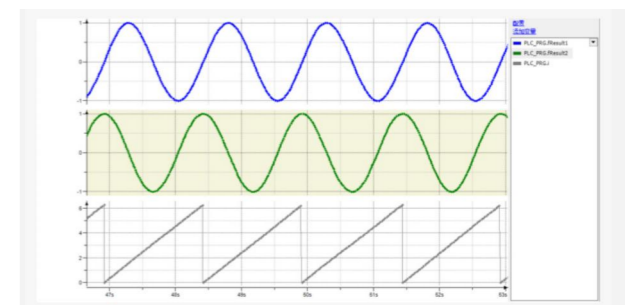

Trace monitor



Function library developing

Product information

MC500 series PLC specification





Model	MC508CS	MC516CS	MC532CS
Specifications	EtherCAT 8 axes + pulse+dir 6 axes	EtherCAT 16 axes + pulse+dir 6 axes	EtherCAT 32 axes + pulse+dir 6 axes
Axes of Pulse +dir	Local 6 axes 200K pulse output		
Extention Capacity	maximum extend 32 R2 series extension modules		
EtherNET	1* EtherNET port, Modbus , Socket,program upload or download ,debugging		
EtherCAT	EtherCAT master , up to 128 slaves		
serial port communication	RS232*1,RS485*2,free communication protocol,modbus rtu master and slave		
CAN	maximum 31 slave		
Capacity of Program file	20 M Byte		
Capacity of data	40 M Byte		
Power-Failure Retention Area	512K Byte		
USB port	Type-C port, program upload or download,debugging		
SD card slot	user download program,standard micro SD card,FAT32 type,Maximum capacity 32G		
Function	Point to point , E-CAM, Interpolation		
High-speed counter	6 inputs ,200K		
IO Quantity	16 inputs High-speed input/ normal input: 12 inputs 200K/4 inputs 1K(NPN/PNP) High-speed output/ normal output: 12 outputs 200K/4 outputs 10K(NPN)		
RTC clock	RTC		
program software	Leadsys Studio ,Codesys V3.5(SP15)		
Program Language	ST,LD,CFC,SFC,FBD,IL		
Power input	DC 24V		
Power rating	3.6W		
Dimension	L 98.50mm*W 81.75mm*H100.00mm		

R2 series extension module

EtherCAT coupler

Diagram	Model	Bus type	Bus Port	Bus Function	Dimension
	R2EC	EtherCAT	2* RJ45,1 input 1 output,rate : 100M	Complies with EtherCAT bus standards, occupies one slave station, can expand up to 32 modules with one coupler	L 100.92mm* W 42.5mm* H 110mm

Digital input module

Diagram	Model	Pins	Input Type	Terminal	Dimension
	PM-1600	16	NPN/PNP	Pressing terminal	L 111.92mm* W 25.9mm* H 101.5mm
	PM-3200	32	NPN/PNP	Pressing terminal	L 111.92mm* W 30.9mm* H 101.5mm
	PM-3200-1	32	NPN/PNP	MIL terminal	L 111.92mm* W 30.9mm* H 101.5mm
	PM-3200-2	32	NPN/PNP	Fujitsu terminal	L 111.92mm* W 30.9mm* H 101.5mm

Analog input module

Diagram	Model	Channels	Input Range	Conversion Time	Resolution	Input Type	Dimension
	PM-A0400-IV	4	1V~5V/0V~5V/ -5V~5V/0V~10V/ -10V~10V/ 0mA~20mA/ 4mA~20mA	1ms/4 channels	16-bit (±3200)	single -ended/ differential	L 111.92mm* W 25.9mm* H 101.5mm

Dimension and parts (PM-1600/PM-3200)

Diagram	Model	Pins	Output Type	Terminal	Dimension
	PM-0016-N	16	NPN	Pressing terminal	L 111.92mm* W 25.9mm* H 101.5mm
	PM-0016-P	16	PNP	Pressing terminal	L 111.92mm* W 25.9mm* H 101.5mm
	PM-0016-R	16	Relay	Pressing terminal	L 111.92mm* W 25.9mm* H 101.5mm
	PM-0032-N	32	NPN	Pressing terminal	L 111.92mm* W 30.9mm* H 101.5mm
	PM-0032-N-1	32	NPN	MIL terminal	L 111.92mm* W 30.9mm* H 101.5mm
	PM-0032-N-2	32	NPN	Fujitsu terminal	L 111.92mm* W 30.9mm* H 101.5mm

Digital I/O module

Diagram	Model	Pins	Output Type	Terminal	Dimension	dimension
	PM-1616-N	32	NPN/PNP	NPN	Pressing terminal	L 111.92mm* W 30.9mm* H 101.5mm

Analog output module

Diagram	Model	Pins	Output Type	Terminal	Dimension	dimension
	PM-A0004-IV	4	1V~5V/0V~5V/ -5V~5V/0V~10V/ -10V~10V/ 0mA~20mA/ 4mA~20mA	1ms/4 channels	16-bit (±3200)	L 111.92mm* W 25.9mm* H 101.5mm

Dimension

MC508CS/MC516CS/MC532CS

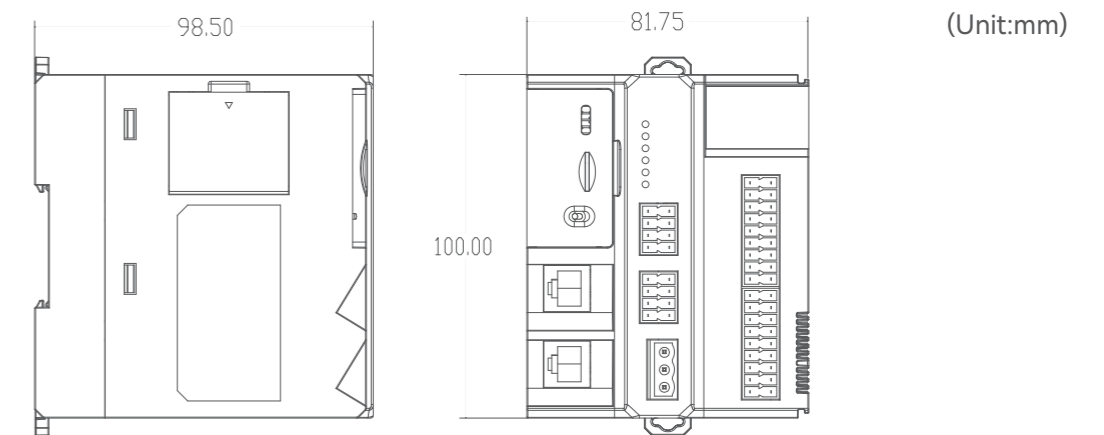

Model and label

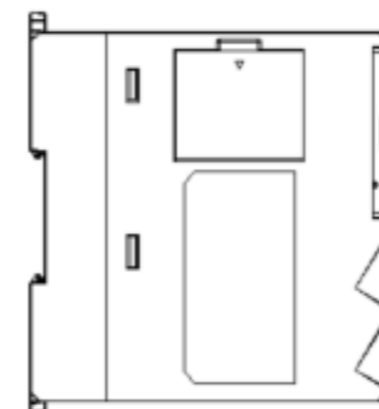
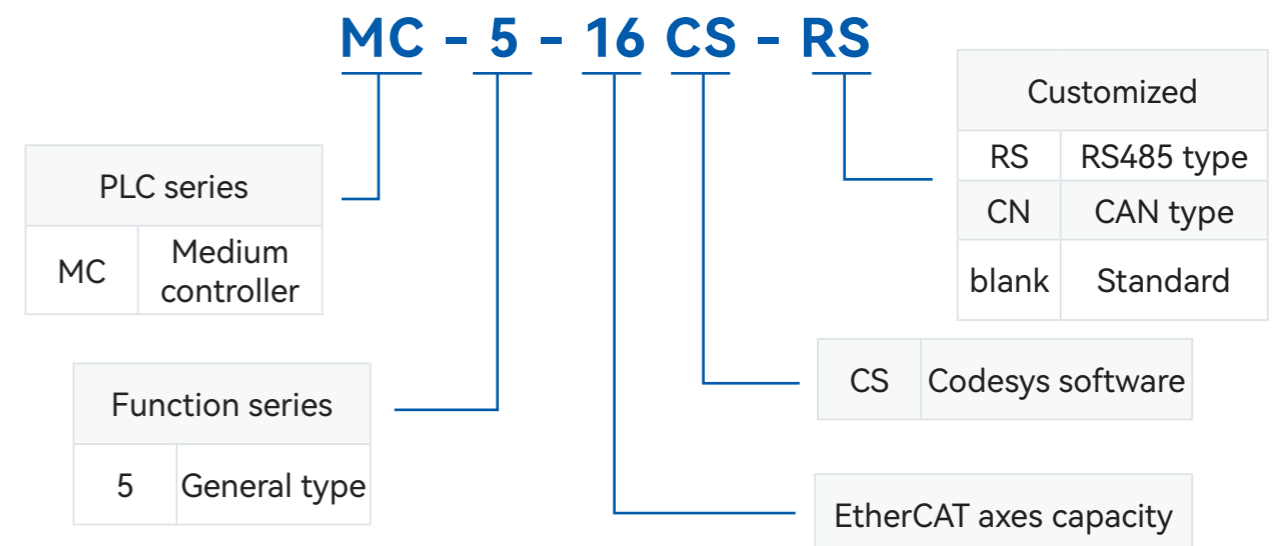

Leadshine
Model:MC516CS
POWER INPUT:DC24V 1A
16DI:DC24V NPN/PNP
16DO:DC24V NPN 0.3A
S/N:XXX-XXX-XXX



Headquarters
China Leadshine Technology Co., Ltd.

☎ +86 755 26411692 📠 +86 755 26402718
🌐 www.leadshine.com
✉ sales@leadshine.com (Sales)
 tech@leadshine.com (Technical Support)
📍 15-20/F, Block B, Nanshan i-Valley, Shuguang Community,
 Xili Town, Nanshan District, Shenzhen 518055, China

North America Office
Leadshine America, Inc.

☎ 1-949-608-7270 📠 1-949-638-7298
🌐 www.leadshineusa.com
✉ sales@leadshineusa.com (Sales)
 support@leadshineusa.com (Technical Support)
📍 26050 Towne Centre Dr. Foothill Ranch, CA 92610 USA

