



Leadshine

Stock Code: 002979



# R2 series

EtherCAT I/O module

## Company Profile

- **Founded in 1997**
- **Public Listed Company in China (002979.SZ)**

### Dedication in Motion Control

- Stepper/Servo systems, Motion Controllers, PLC
- Control systems, I/O Modules, Encoders
- **A leading supplier of motion control products and solutions in the world**
- **Customer Oriented, Technology Oriented, Forever Improving, Sharing of Success**



Leadshine Shenzhen Headquarter



Shanghai Intelligent Industry Park



Production base in Shenzhen

### R&D

Led by Dr. Li, a PhD majored in robotics & servo controls from MIT, Leadshine has one of the strongest R&D teams in the motion control industry.

The team consists of more than 100 R&D engineers and all of them are highly educated with most of them carry PhD & Master degrees in controls, electrical & electronics engineering, mechanical engineering, mechatronics, computer engineering, and computer science.

Their strong background and experience allow Leadshine capable of designing superior quality products based the latest technology in the most efficient way.

### Product Quality

Leadshine operates manufacturing facilities which are superiorly equipped, professionally staffed, and ISO-9001 certified.

That allows Leadshine to provide highly reliable quality motion control products OEM clients in the shortest time.

Leadshine's products have proven records of being successfully adopted in thousands of applications such as CNC routers, mills, plasmas, lathes, laser cutters/engravers/markers, inkjet printers, plotters, electronics equipments, medical equipments, semiconductor assembly & inspection machines, electronics machines, packaging equipments, textile machines, robotics, pick-and-place devices, etc. In most cases, Leadshine's standard "off-the-shelf" products are able to satisfy the motion control needs for most applications.

For many OEM applications with special requirements, Leadshine also offers customized products with optimized performance.

### Support and Service

Leadshine believes the key to be a successful motion product supplier is the commitment to fully understanding our customer's applications and working closely with our OEM clients.

In many cases, Leadshine engineers can participate in the whole process of client product development, including initial application evaluation, product selection, design help & suggestion.

Our expertise and experience allow us to help OEM clients to produce competitive high quality machines in their industries.

**Your Reliable Motion Control Partner**

## R2 SERIES GENERAL TYPE

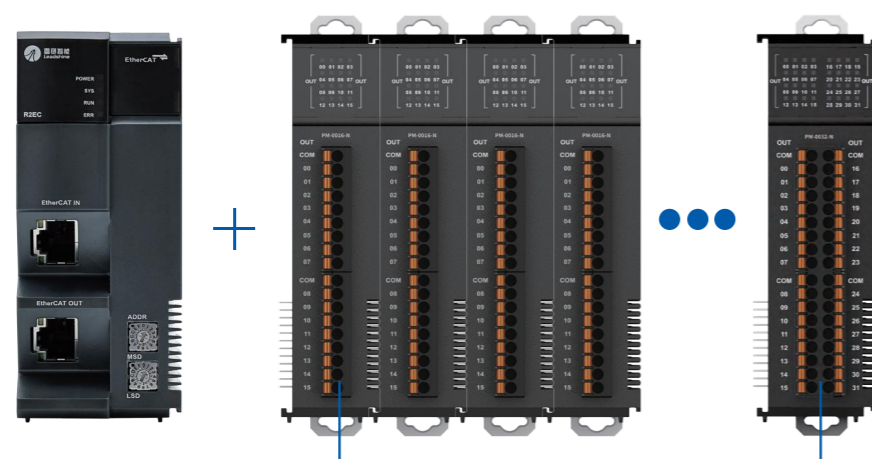

As a high-speed real-time EtherNET, EtherCAT bus makes it possible to separate the master device and I/O. High-speed synchronization with the EtherCAT network increases efficiency and expands the connection to the sensing layer required for production lines and for most applications. It also provides significant savings in wiring and maintenance costs.

Leadshine R2 series I/O module supports standard network protocols and connecting to various mainstream masters.

R2 series I/O module includes digital, analog, temperature, encoder, etc.

It can be configured according to the needs of the applications to meet the demands of customers.

## CONTENTS

Product naming rules	03
R2 series I/O module	04
R2 series coupler introduction	05
R2 series extension module introduction	09
Digital module	11
Analog module	21
R2 series I/O module software functions	25
Ordering information	26

# Architecture diagram of motion control system

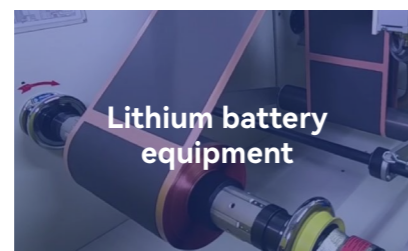
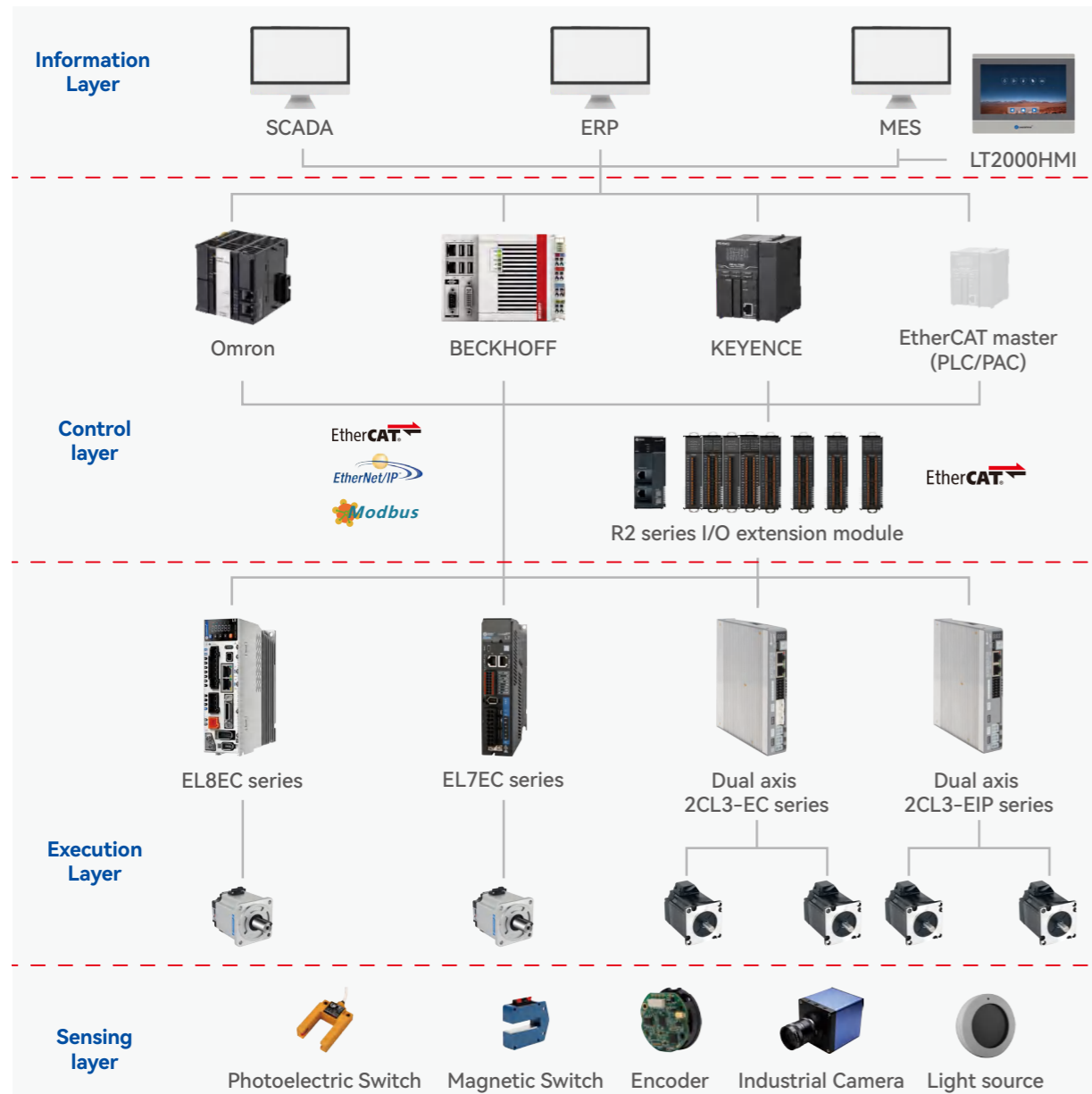

Leadshine intelligent motion control products cover all scenarios of general automation applications, providing a complete set of comprehensive solutions based on information layer, control layer, execution layer, and sensing layer, and achieving widespread applications. We continuously provide stable, reliable, and high value-added motion control products and solutions for many OEM manufacturers, lithium batteries, photovoltaics, electronics, semiconductors, packaging, logistics, and other industries.

## General purpose R2 series I/O module

### R2ECCoupler

- R2EC EtherCAT

### Digital extension module

- PM-1600, 16 digital inputs module PNP/NPN input
- PM-3200, 32 digital inputs module PNP/NPN input
- PM-3200-1, 32 digital inputs module PNP/NPN input, MIL terminal
- PM-3200-2, 32 digital inputs module PNP/NPN input, Fujitsu terminal
- PM-0016-N, 16 digital output module, NPN output
- PM-0016-R, 16 digital output module, Relay output
- output PM-0032-N, 32 digital output module, NPN output
- output PM-0032-N-1, 32 digital output module, NPN output, MIL terminal
- PM-0032-N-2, 32 digital output module, NPN output, Fujitsu terminal
- PM-1616-N, 32 digital I/O module, PNP/NPN input, NPN output
- PM-0016-P, 16 digital output module, PNP output



### analog extension module

- PM-A0400-IV, 4 analog input module
- PM-A0004-IV, 4 analog output module

### motion control extension module

- PM-E0200-S, 2 encoder input module, single-ended input
- PM-E0200-D, 2 encoder input module differential input

### Temperature extension module

- PM-T0400-TC, 4 temperature module, thermocouple type
- PM-T0400-TR, 4 temperature module, thermal resistance type

# R2 series I/O extension module naming rules

## coupler naming rules

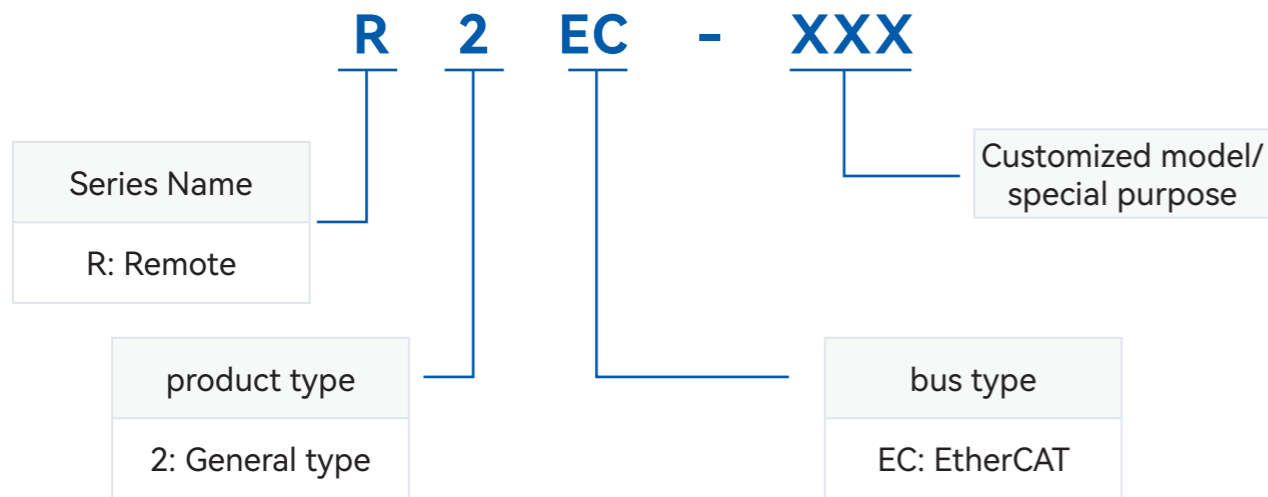

## I/O extension module naming rules

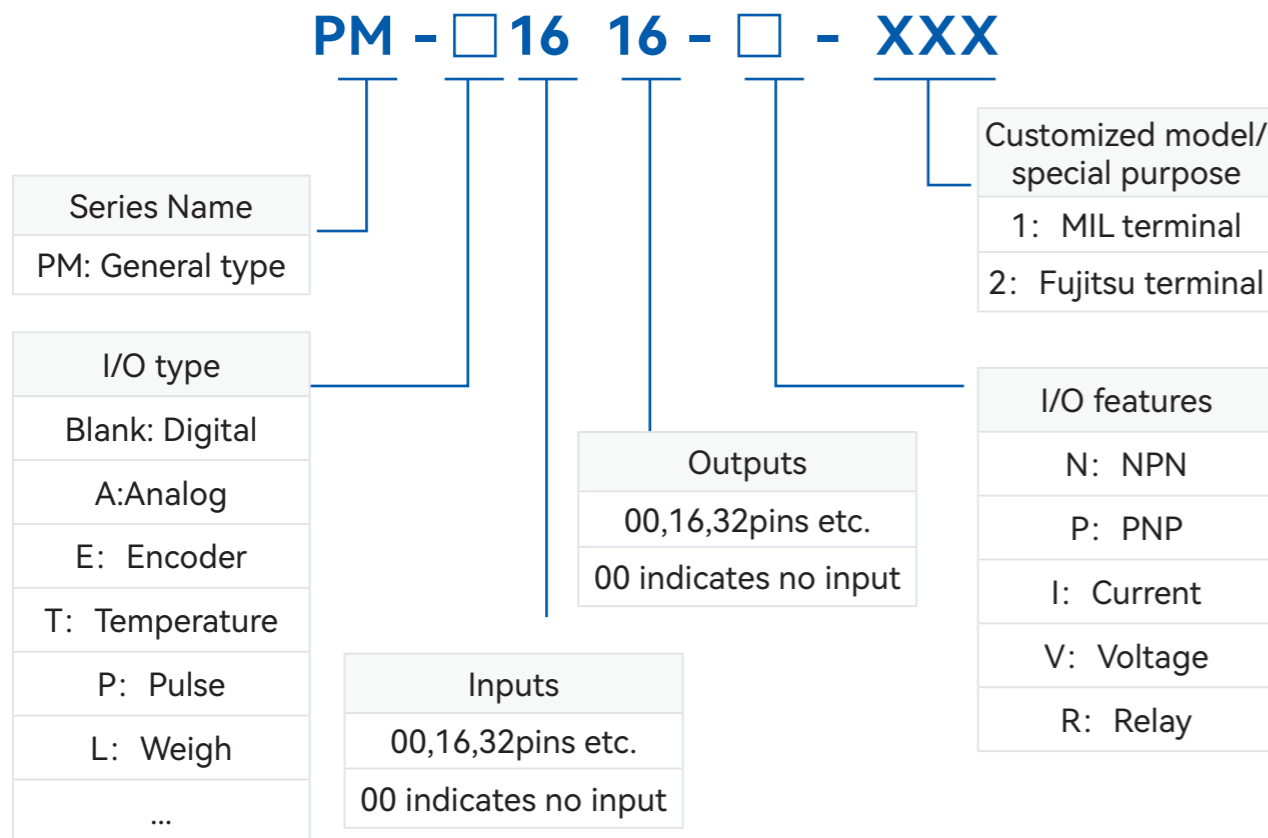

# R2 series I/O extension module

- R2EC coupler
- Power module
- R2 series I/O extension module



## I/O extension module product composition

<b>Coupler</b>		<b>Power module</b>	
	R2EC		PM02PS-A0
<b>I/O Extension Module</b>	<b>Digital module</b>	 PM-1600 PM-3200 PM-3200-1 PM-3200-2 PM-0016-N PM-0016-R PM-0016-P PM-0032-N PM-0032-N-1 PM-0032-N-2 PM-1616-N	
	<b>Analog module</b>	 PM-A0400-IV PM-A0004-IV	
	<b>Temperature module</b>	 PM-T0400-TC PM-T0400-TR	<b>Encoder input module</b>

## R2 series coupler

### Product model and technical specification



Specifications	Model	R2EC
Power	Input Power	DC24V(-15%~+20%),2A
	Output Power	DC24V(-15%~+20%),2A
Extension	Bus type	EtherCAT
	Bus port	RJ45 crystal head (inclined at 30 degrees), internal connector
Bus performance	Physical port	2*RJ45 with green and yellow status indicator light,one input one output ,rate :100M
	Bus type	EtherCAT
	Bus functions	Complies with EtherCAT bus standards, occupies one slave station, can expand up to 32 modules with one coupler, and supports SM/DC synchronization mode
Others	Installation	Standard DIN rail
	Dimension	L100.92mm*W42.5mm*H110mm
	Certification	CE

### Dimension and parts

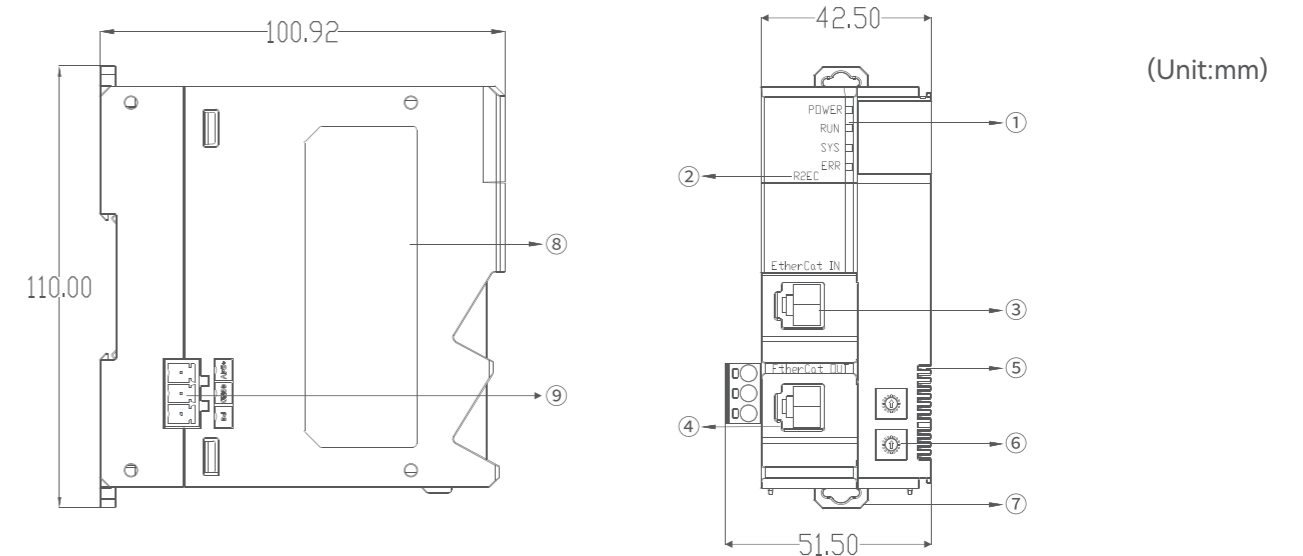

No.	Label	description
①	Panel indicator light	POWER:Power indicator light(green) SYS:System running indicator light(green) RUN:EtherCAT Bus indicator light(green) ERR:EtherCAT Bus alarm indicator light(red)
②	Module name	Adapter model
③	EtherCAT·IN	RJ45network indicator light: Green: Link,constant light indicates successful link Yellow: Active,flashing indicates data transmission Theflashing rule meets the standards defined by the EtherCATbus
④	EtherCAT·OUT	Green: Link,constant light indicates successful link Yellow: Active,flashing indicates data transmission Theflashing rule meets the standards defined by the EtherCATbus
⑤	Extension module communication port	To communication with other extension modules
⑥	Switch	Set the slave node number
⑦	Snap	To install on DIN rail
⑧	Label	Product information
⑨	Power port	Power port, DC24V, +24V、EGND、PE from top to bottom

## Power module

### Product model and technical specification



**PM02PS-A0**

### Dimension and parts

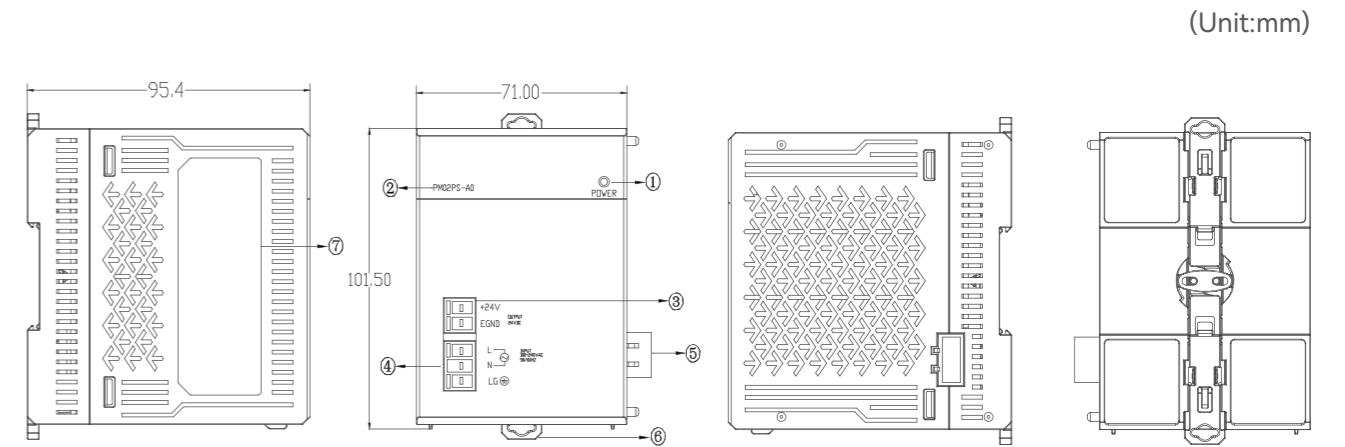

Specifications		Model	PM02PS-A0
Input power	Input voltage	AC100-240V, 50/60Hz	
	Input port	3PIN power pins,define L/N/LG Interface is on the front of the module	
Output power	Output voltage	1.System power DC24V 2A 2.I/O power DC24V 0.5A Equipped with short-circuit protection and over-current protection	
	Output port	Two 24V power output connections, one 2PIN power terminal connect to the positive side of the module,one 3PIN power terminal connect to the right side of the module for providing power to the right PMC host and Adapter 3PIN power port :E24V/EGND/PE	
Others	Indicator light	Panel system power indicator light (green)	
	Installation	Standard DIN rail	
	Dimension	L 95.4mm*W 71mm*H 101.5mm	
	Certification	CE	

No.	Label	Description
①	Power indicator light	Connecting to the power supply, indicator light comes on
②	Module name	Module model
③	Terminal	Output voltage: 24V/2A
④	Terminal	Input voltage: AC100~240V
⑤	Terminal	Output: Power supply for the right MC host and adapter
⑥	Snap	To install on DIN rail
⑦	Label	Product information

## R2 series I/O extension module

- Digital input module
- Digital output module
- Digital I/O module
- Analog input module
- Analog output module



### I/O Extension module product introduction

The R2 series plug-in module is an I/O extension module developed by Leadshine based on the EtherCAT Bus protocol, it has a strong versatility, not only with Leadshine motion control card, motion control PLC master stations also can be used with other mainstream main stations. At the same time, it is small

in size and highly integrated, single module supports 16 I/O or 32 I/O. The input and output interfaces of the I/O extension module adopt optoelectronic isolation and filtering technology, which can effectively isolate external circuit interference.

### I/O extension module product composition

Module series	Model	Description
Digital input module	PM-1600	16 digital inputs module PNP/NPN input
	PM-3200	32 digital inputs module PNP/NPN input
	PM-3200-1	32 digital inputs module PNP/NPN input, MIL terminal
	PM-3200-2	32 digital inputs module PNP/NPN input, Fujitsu terminal
Digital output module	PM-0016-N	16 digital outputs module, NPN output
	PM-0016-R	16 digital outputs module, Relay output
	PM-0016-P	16 digital outputs module, PNP output
	PM-0032-N	32 digital outputs module, NPN output
	PM-0032-N-1	32 digital outputs module, NPN output, MIL terminal
	PM-0032-N-2	32 digital outputs module, NPN output, Fujitsu terminal
Digital I/O module	PM-1616-N	32 digital I/O module, PNP/NPN input, NPN output
Analog input module	PM-A0400-IV	4 analog input module, current/voltage input
Analog output module	PM-A0004-IV	4 analog output module, current/voltage output
Temperature module	PM-T0400-TC	4 temperature module, thermocouple type
	PM-T0400-TR	4 temperature module, thermal resistance type
Encoder input module	PM-E0200-S	2 encoder input module, single-ended input
	PM-E0200-D	2 encoder input module, differential input

### I/O Extension module features

#### Flexible combination

I/O extension module support 16 inputs, 16 outputs, 32 inputs, 32 outputs, 32 I/O.

#### Rich variety

Include coupler I/O extension module, analog module, Temperature module, Encoder input module.

#### Extension method

R2 series I/O Extension module include Coupler and I/O extension module, adopting the right extension method, single coupler can mount up to 32 I/O extension modules.

#### High speed and efficiency

Adopting an internal backplane communication protocol of up to 100M, Has very high I/O refresh speed and can achieve high-speed input output response

#### Wide adaptability

The module adopts a sliding rail design to ensure the stability of the connection between the modules, while making it easy to plug and unplug, facilitate electrical assembly, and modify network nodes.

#### Safe operation

The bus disconnection protection function can set whether the output status of the bus disconnection module is maintained, ensuring the safe operation of the equipment in case of accidental disconnection.



# Digital input module

## Product model and technical specification

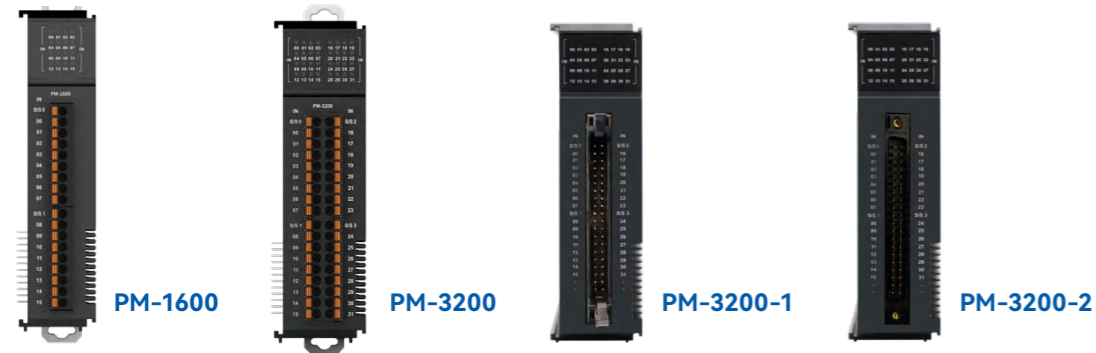

Specifications		Model	PM-1600	PM-3200	PM-3200-1	PM-3200-2
I/O	Input pins		16	32	32	32
	Output pins		\			
Extension	Bus type		Internal backplane bus			
	Bus port		12PIN connector, internal backplane bus and power supply			
Power supply	Input voltage/current		DC 24V(-15% - +20%),2A			
I/O performance	Input control		Control power supply 24VDC, isolated			
	Single pin input voltage/current		DC 24V(-15% - +20%),5mA			
	Input OFF-ON		Over DC 15V, Current above 1.5mA			
	Input ON-OFF		Below DC 5V, Current above 1mA			
	Input frequency		10K			
	Input ON/OFF response time		20μs/50μs			
	Input type		NPN/PNP			
	Input resistance		4.7KΩ (max)			
	Input protection		Optocoupler isolated, anti-interference			
	Common		1 common for every 8 outputs			
	Power rating		24V/47mA	24V/53mA	24V/34mA	24V/34mA
I/O functions	Input function		Digital signal ON-OFF detection			
Others	Power port		Input and output is supplied 24V power supply by 12PIN			
	I/O terminal		Plug type terminals, gap 3.5mm, black orange colored	MIL connector	Fujitsu connector	
	Indicator light		Every input corresponds to 1 indicator light. Lights up when input ON, light off when input OFF			
	Installation		Standard DIN rail			
	Dimension		L 111.92mm* W 25.9mm* H 101.5mm	L 111.92mm*W 30.9mm*H 101.5mm		
	Certification		CE			

## Dimension and parts (PM-1600/PM-3200)

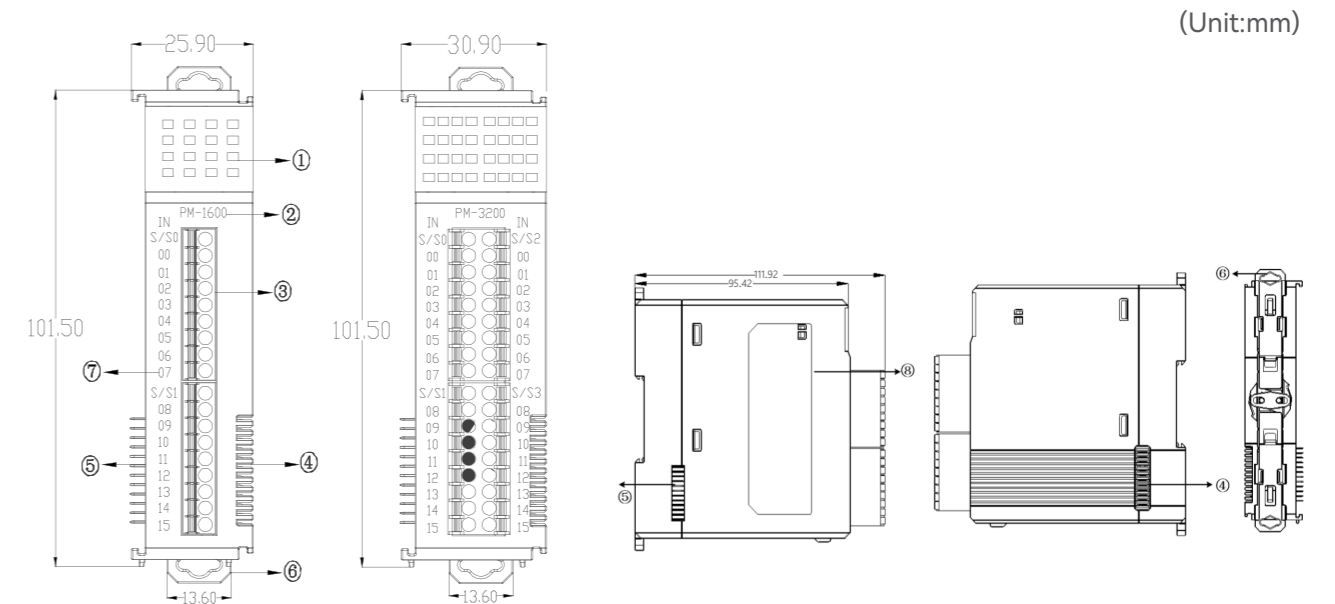

No.	Label	Description
①	output indicator light	Light up when output signal is valid
②	Module name	Module name
③	Terminal	Output signal line
④	Extension module communication port	To communication with other extension modules
⑤	Extension module communication port	To communication with other extension modules
⑥	Snap	To install on DIN rail
⑦	Pin number	Indicates output pin No.
⑧	Label	Product information

# Digital output module

## Product model and technical specification



Specifications		Model	PM-0016-N	PM-0016-P	PM-0032-N	PM-0032-N-1	PM-0032-N-2
I/O	Input pins	\					
	Output pins	16	16	32	32	32	
Extension	Bus type	Internal backplane bus					
	Bus port	12PIN connector, internal backplane bus and power supply					
Power supply	Input voltage/current	DC 24V(-15% - +20%),2A					
I/O performance	Output current	500mA/route (Peak/Full load300mA)					
	Output voltage	5-24V					
	Output frequency	Low speed 10K	Low speed 1K	Low speed 10K	Low speed 10K	Low speed 10K	
	Output ON/OFF response time	20µs/50µs	15µs/40µs	20µs/50µs	20µs/50µs	20µs/50µs	
	Output type	NPN	PNP	NPN	NPN	NPN	
	Output protection	Against short circuit, over current. Opto-isolation					
	Common	1 common for every 8 outputs, common terminal is GND and externally grounded					
	Power rating	24V/69mA	24V/137mA	24V/107mA	24V/59mA	24V/59mA	
I/O functions	Output function	Digital signal ON-OFF control					
Others	Power supply port	Input and output is supplied 24V power supply by 12PIN					
	I/O terminal	Plug type terminals, gap 3.5mm, black orange colored			MIL connector	Fujitsu connector	
	Indicator light	18 (16-pin OUT) Each terminal has 9 pin with upper and bottom parts independent from each other	20 (16-pin OUT) Each terminal has 10 pin with upper and bottom parts independent from each other	36 (32-pin OUT) Each terminal has 18 pin with upper and bottom parts independent from each other	40 (32-pin OUT)		
	Installation	Standard DIN rail					
	Dimension	L 111.92mm*W 25.9mm* H 101.5mm			L 111.92mm*W 30.9mm*H 101.5mm		
	Certification	CE					

## Dimension and parts (PM-1600/PM-3200)

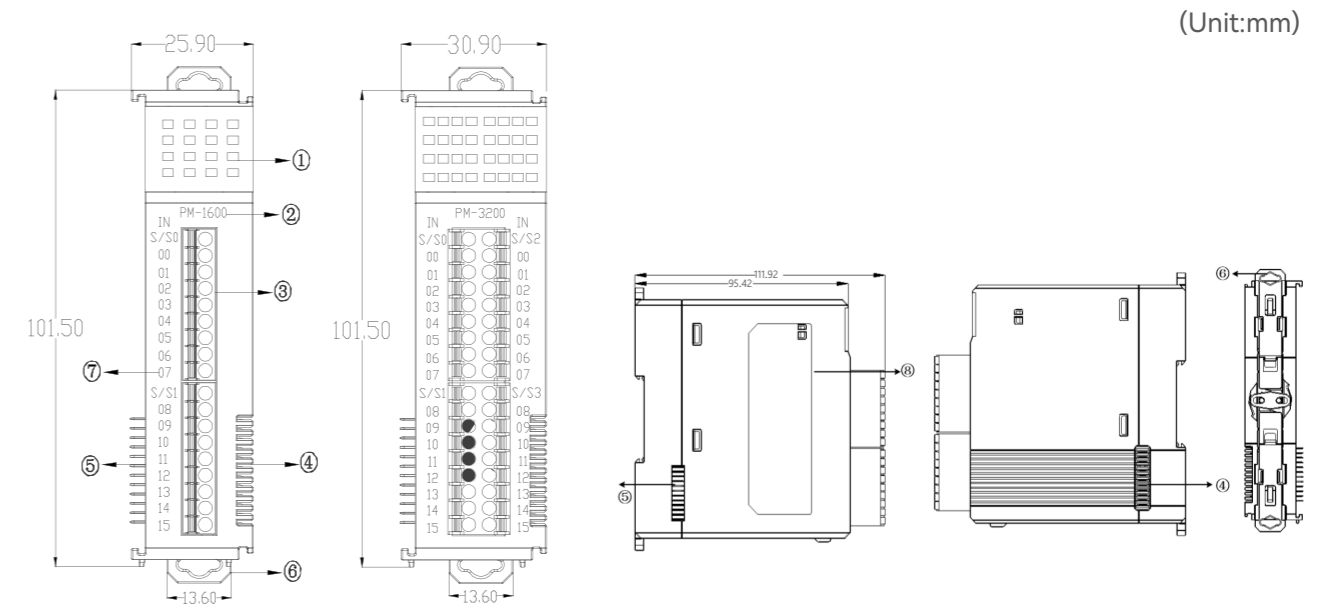

No.	Label	Description
①	output indicator light	Light up when output signal is valid
②	Module name	Module name
③	Terminal	Output signal line
④	Extension module communication port	To communication with other extension modules
⑤	Extension module communication port	To communication with other extension modules
⑥	Snap	To install on DIN rail
⑦	Pin number	Indicates output pin No.
⑧	Label	Product information

## Dimension and parts (PM-0016-P)

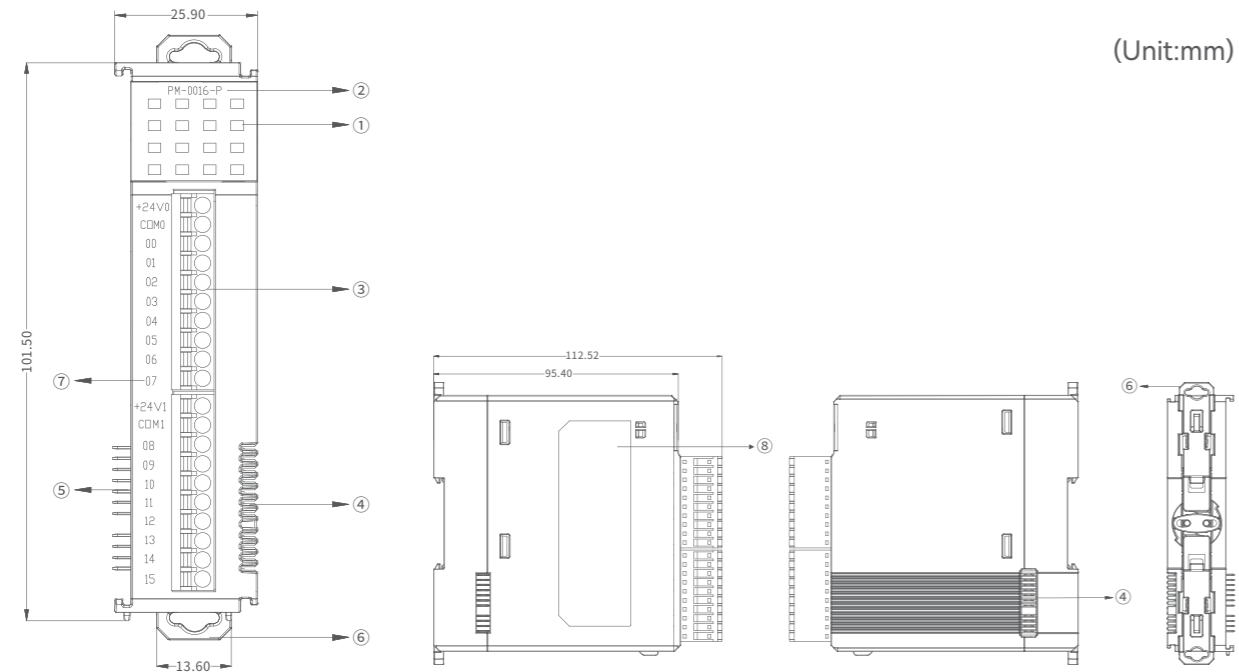

No.	Label	Description
①	output indicator light	Light up when output signal is valid
②	Module name	Module name
③	Terminal	Output signal line
④	Extension module communication port	To communication with other extension modules
⑤	Extension module communication port	To communication with other extension modules
⑥	Snap	To install on DIN rail
⑦	Pin number	Indicates output pin No.
⑧	Label	Product information

## Dimension and parts (PM-0032-N-1)

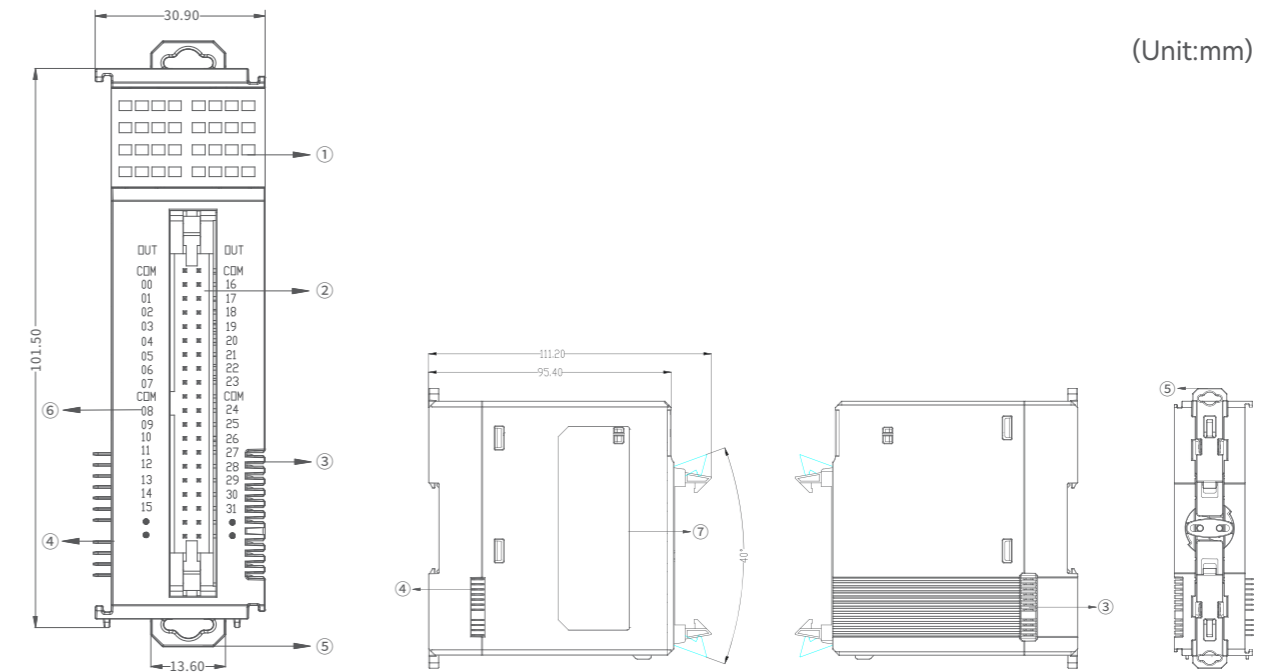

No.	Label	Description
①	output indicator light	Light up when output signal is valid
②	Terminal	Output signal line
③	Extension module communication port	To communication with other extension modules
④	Extension module communication port	To communication with other extension modules
⑤	Snap	To install on DIN rail
⑥	Pin number	Indicates output pin No.
⑦	Label	Product information

## Relay output module

### Product model and technical specification

### Dimension and parts (PM-1600/PM-3200)

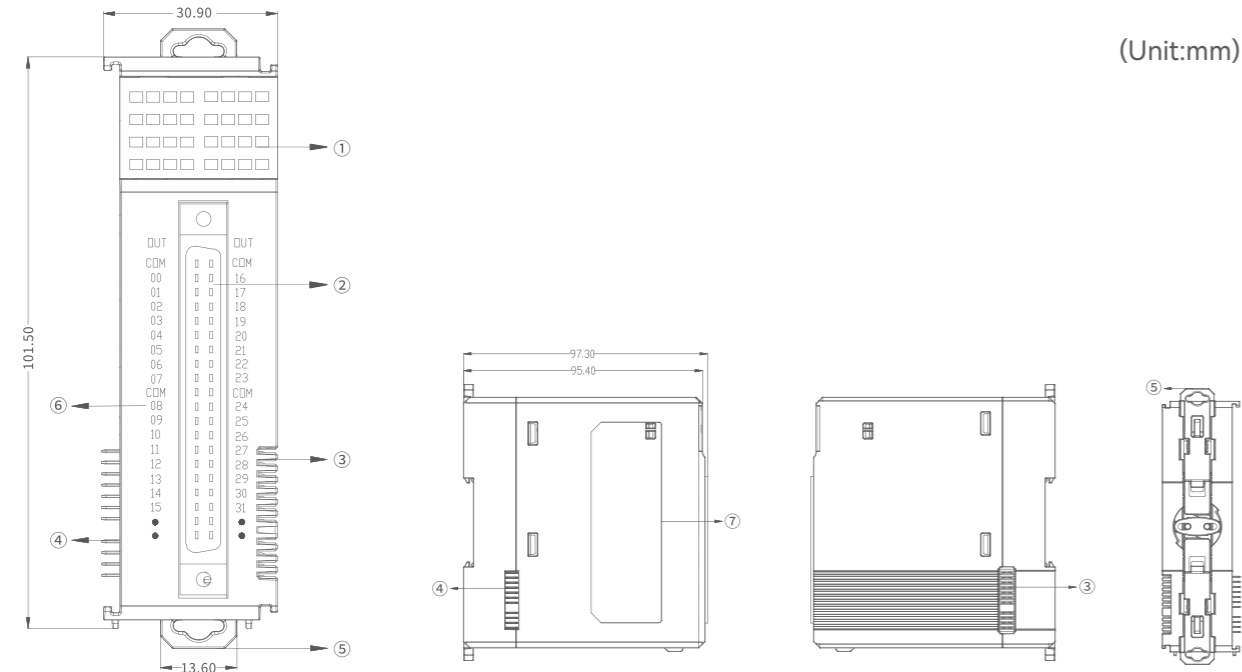

No.	Label	Description
①	output indicator light	Light up when output signal is valid
②	Terminal	Output signal line
③	Extension module communication port	To communication with other extension modules
④	Extension module communication port	To communication with other extension modules
⑤	Snap	To install on DIN rail
⑥	Pin number	Indicates output pin No.
⑦	Label	Product information



**PM-0016-R**

Specifications		Model	PM-0016-R
I/O	Input pins		0
	Output pins		16
Extension	Bus type		Internal backplane bus
	Bus port		12PIN connector, internal backplane bus and power supply
I/O performance	Power rating		AC250V/DC30V,2A (single input)
	Output ON/OFF response time		OFF-ON,<15ms ON-OFF,<15ms
	Output type		Relay
	Common		4 common for every 16 outputs
	Working frequency		Max 1Hz
	Relay switch times		inductive load:20000Times@DC30V2A Resistive load:100000Times@DC30V、 AC
I/O function	Output function		Digital signal on/off control
Others	Power port		Power supply by 12PIN,AC250V/DC30V
	I/O terminal		Plug type terminals, gap 3.5mm, black orange colored
	Indicator light		Every output corresponds to 1 indicator light. Lights up when output ON, light off when output OFF
	Installation		Standard DIN rail
	Dimension		L 111.92mm*W 25.9mm*H 101.5mm
	Certification		CE

# Digital I/O Module

## Product model and technical specification

**PM-1616-N**

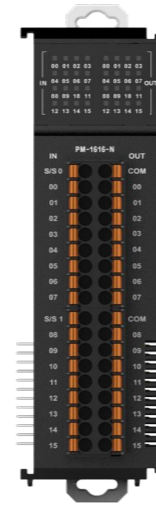

Specifications	Model	PM-1616-N
I/O	Input pins	16
	Output pins	16
Extension	Bus type	Internal backplane bus
	Bus port	12PIN connector, internal backplane bus and power supply
Power supply	Input voltage/current	DC 24V(-15% - +20%),2A
	Power supply port	Input and output is supplied 24V power supply by 12PIN
I/O performance	Input control	Control power supply 24VDC, isolated
	Single pin input voltage/current	DC 24V(-15% - +20%),5mA
	Input OFF-ON	Over DC 15V, Current above 1.5mA
	Input ON-OFF	Below DC 5V, Current above 1mA
	Output current	500mA/route (Peak/Full load300mA)
	Output voltage	5-24V
	Input frequency	10K
	Output frequency	Low speed, 10K
	I/O ON/OFF response time	20μs/50μs
	Input type	NPN/PNP
	Output type	NPN
	Input resistance	4.7KΩ(Max)
	Input protection	Optocoupler isolated, anti-interference
	Output protection	Against short circuit, over current. Opto-isolation
I/O function	Common	1 common for every 8 outputs
	Power rating	24V/59mA
I/O function	Output function	Digital signal on/off control
	Input function ①	Digital signal ON-OFF detection
Others	Output function ②	Digital signal ON-OFF control
	I/O terminal	Plug type terminals, gap 3.5mm, black orange colored
	Indicator light	Every I/O corresponds to 1 indicator light. Lights up when signal ON, light off when signal OFF.
	Terminal	36 (16-pin OUT, 16-pin IN) Each terminal has 18 pin with upper and bottom parts independent from each other
	Installation	Standard DIN rail
	Dimension	L 111.92mm*W 30.9mm*H 101.5mm
	Certification	CE

## Dimension and parts

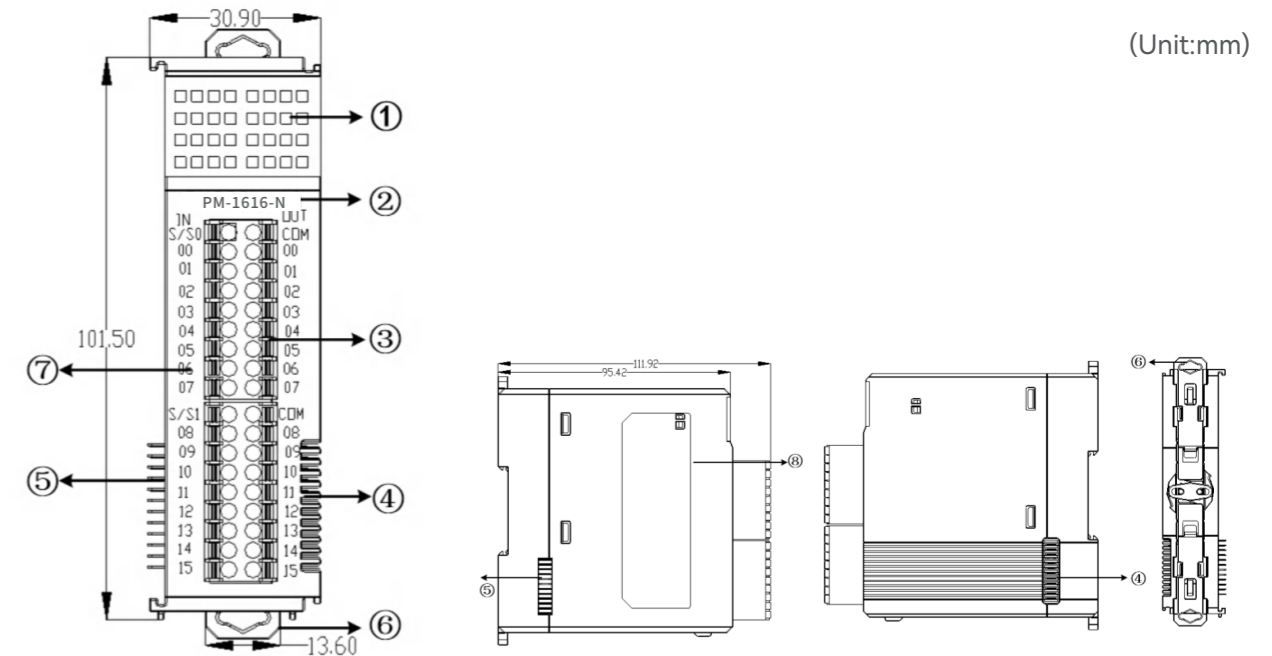

(Unit:mm)

No.	Label	Description
①	I/O indicator light	Light up when I/O signal is valid
②	Module name	Module name
③	Terminal	Input: Sensor and switch wiring
④	Extension module communication port	Output: Driver's load wiring
⑤	Extension module communication port	To communication with other extension modules To communication with other extension modules
⑥	Snap	To install on DIN rail
⑦	Pin number	Indicates I/O pin no.
⑧	Label	Product information

# Analog input module

## Product model and technical specification



**PM-A0400-IV**

Specifications	Model	PM-A0400-IV								
AD performance	Input type	voltage/current								
	Input channels	4								
	Rating input range	1V~5V	-5V~5V	0V~10V	-10V~10V	0V~5V	4mA~20mA	0mA~20mA	-20mA~20mA	
	Rating digital conversion range	0~32000	-32000~32000	0~32000	-32000~32000	0~32000	0~32000	0~32000	0~32000	0~32000
	Resolution	16-bit								
	Input resistance	Voltage input resistance: > 1MΩ; Current sampling resistance: 250Ω								
	Overall accuracy (25°C)	Voltage±0.1%; Current±0.2%								
	Overall accuracy (0~55°C)	Voltage±0.2%; Current±0.3%								
	Response time	1ms/4 Channels								
	Input method	Single-ended/differential (compatible)								
Data format	Integer									
Alarm	Software+hardware indicator									
Others	Power supply port	Power supply by 12PIN, 24V								
	I/O terminal	Plug type terminals, gap 3.5mm, black orange colored								
	Indicator light	RUN (green) /ERR(red)two indicator light (RUN: running status indicator light, After power on, it will light up normally and go out if a fault occurs; ERR: error status indicator light, go out if a fault occurs)								
	Installation	Standard DIN rail								
	Dimension	L 111.92mm*W 25.9mm*H 101.5mm								
	Label	Product information								
	Certification	CE								
Hardware circuit over-voltage protection	Analog limit 24V, power limit 30V									

## Dimension and parts

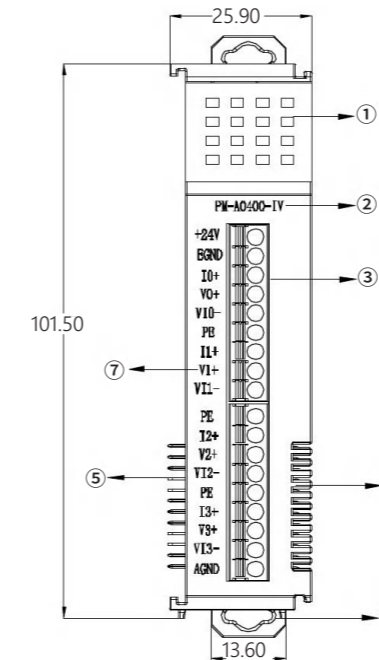

(Unit:mm)

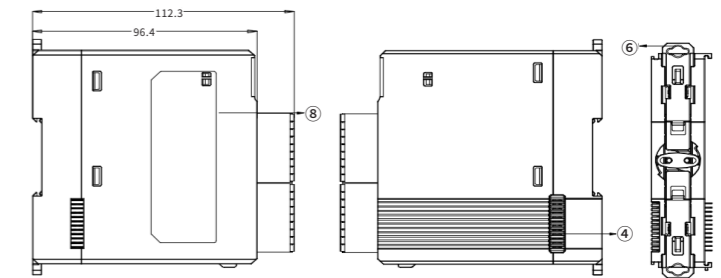

No.	Label	Description
①	Status indicator light	RUN、ERR indicator light
②	Module name	Module name
③	Terminal	4 input (voltage or current input)
④	Extension module communication port	To communication with other extension modules
⑤	Extension module communication port	To communication with other extension modules
⑥	Snap	To install on DIN rail
⑦	Pin number	Indicates I/O pin no.
⑧	Label	Product information

# Analog output module

## Product model and technical specification

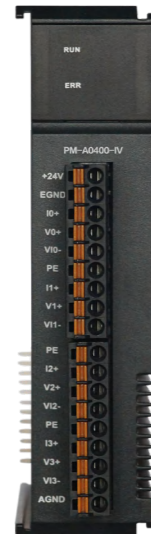

**PM-A0004-IV**

Specifications	Model	PM-A0400-IV							
AD performance	Output type	voltage/current							
	Output channels	4							
	Rating input range	1V~5V	0V~5V	-5V~5V	0V~10V	-10V~10V	0mA~20mA	4mA~20mA	
	Rating digital conversion range	0~32000	0~32000	-32000~32000	0~32000	-32000~32000	0~32000	0~32000	
	Resolution	16-bit							
	Output resistance	Voltage output load: 1K~1MΩ; Current load resistance: 100Ω~500Ω							
	Overall accuracy (25°C)	Voltage: ±0.1%; Current: ±0.2%							
	Overall accuracy (0~55°C)	Voltage: ±0.2%; Current: ±0.3%							
	Response time	1ms/4 channels							
	Output method	Single-ended/differential (compatible)							
Others	Data format	Integer							
	Alarm	Software+hardware indicator							
	Power supply port	Power supply by 12PIN, 24V							
	Power protection	Over-current protection, reverse polarity protection							
	I/O terminal	Plug type terminals, gap 3.5mm, black orange colored							
	Indicator light	RUN (green) /ERR(red)two indicator light (RUN: running status indicator light, After power on, it will light up normally and go out if a fault occurs; ERR: error status indicator light, go out if a fault occurs)							
	Installation	Standard DIN rail							
	Dimension	L 111.92mm*W 25.9mm*H 101.5mm							
	Label	Product information							
	Certification	CE							
Hardware circuit over-voltage protection	Analog limit 24V, power limit 30V								

## Dimension and parts

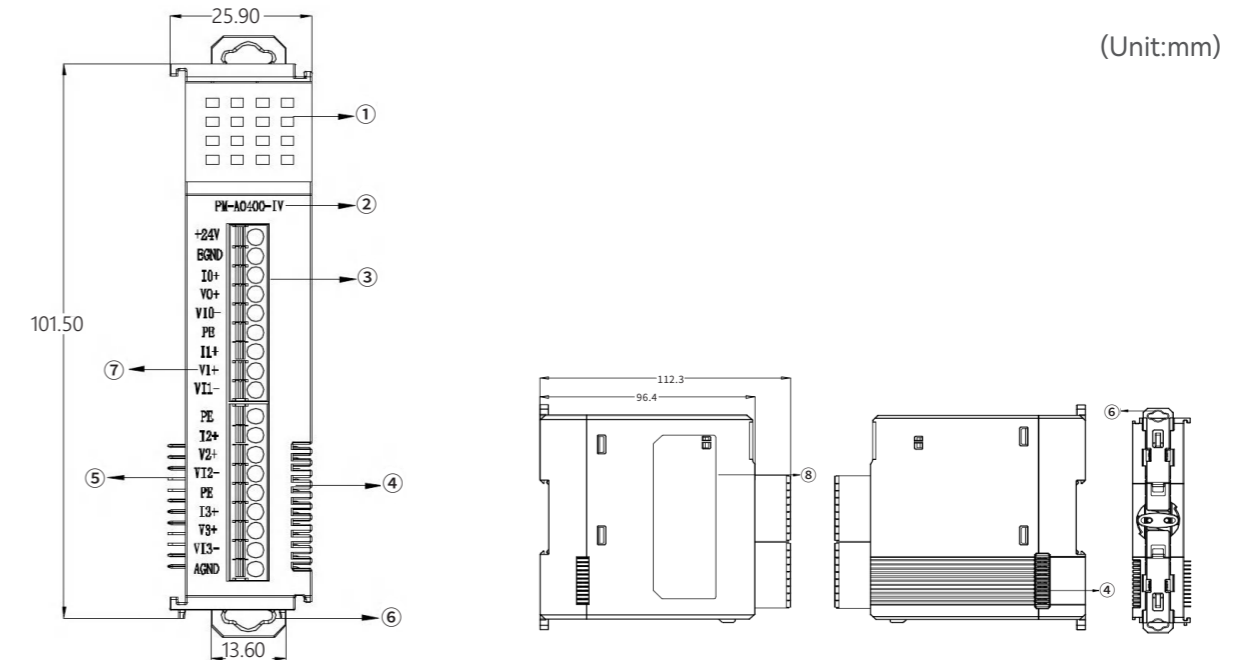

No.	Label	Description
①	Status indicator light	RUN、ERR indicator light
②	Module name	Module name
③	Terminal	4 output (voltage or current output)
④	Extension module communication port	To communication with other extension modules
⑤	Extension module communication port	To communication with other extension modules
⑥	Snap	To install on DIN rail
⑦	Pin number	Indicates I/O pin no.
⑧	Label	Product information

## R2 series I/O Extension module software function

### Flexible configuration of different bus master stations

- Add the Leadshine Intelligent R series coupler and remote I/O module to the master station programming software for hardware configuration. After downloading the configuration, the number of master and slave stations can be established According to communication.
- Omron master config leadshine R2 series I/O Extension module.

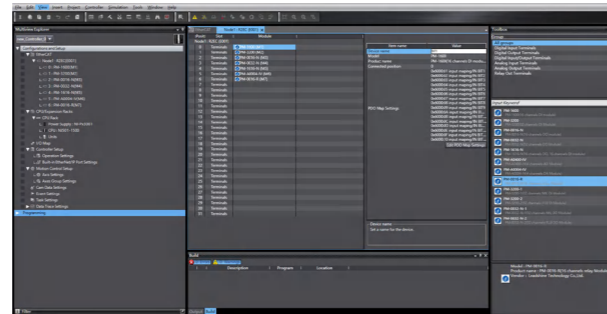
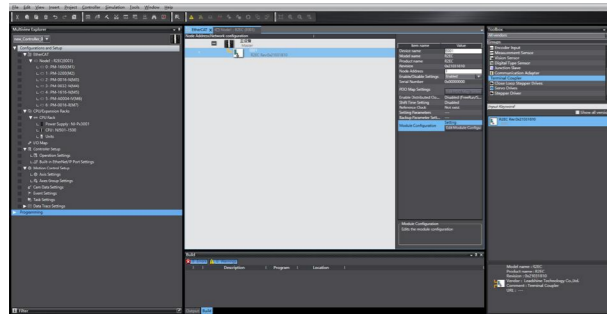

## Ordering information

### R2 series I/O Extension module

Module Type	Model	Description
Coupler	R2EC	EtherCAT bus coupler, 32Plug-in module
Digital input module	PM-1600	16digital inputs module PNP/NPN input
	PM-3200	32 digital inputs module PNP/NPN input
	PM-3200-1	
Digital output module	PM-0016-N	16 digital outputs module , NPN output
	PM-0016-R	16 digital outputs module, Relay output
	PM-0016-P	16 digital outputs module, PNP output
	PM-0032-N	32 digital outputs module , NPN output
	PM-0032-N-1	
	PM-0032-N-2	
Digital I/O module	PM-1616-N	32 digital I/O module, PNP/NPN input, NPN output
Analog input module	PM-A0400-IV	4 analog input module, current/voltage input
Analog output module	PM-A0004-IV	4 analog output module, current/voltage output
Temperature module*	PM-T0400-TC*	4 temperature module ,thermocouple type
	PM-T0400-TR*	4 temperature module,thermal resistance type
Encoder input module*	PM-E0200-S*	2 encoder input module ,single-ended input
	PM-E0200-D*	2 encoder input module, differential input

Note\*: "\*" indicates upcoming release, please stay tuned

### Multiple ways to troubleshoot faults

- The communication fault situation can be displayed synchronously through the ERR and CF fault indicator lights defined on the distributed I/O panel, and can also be diagnosed and identified by the main station to assist users in quickly locating the cause of the fault.

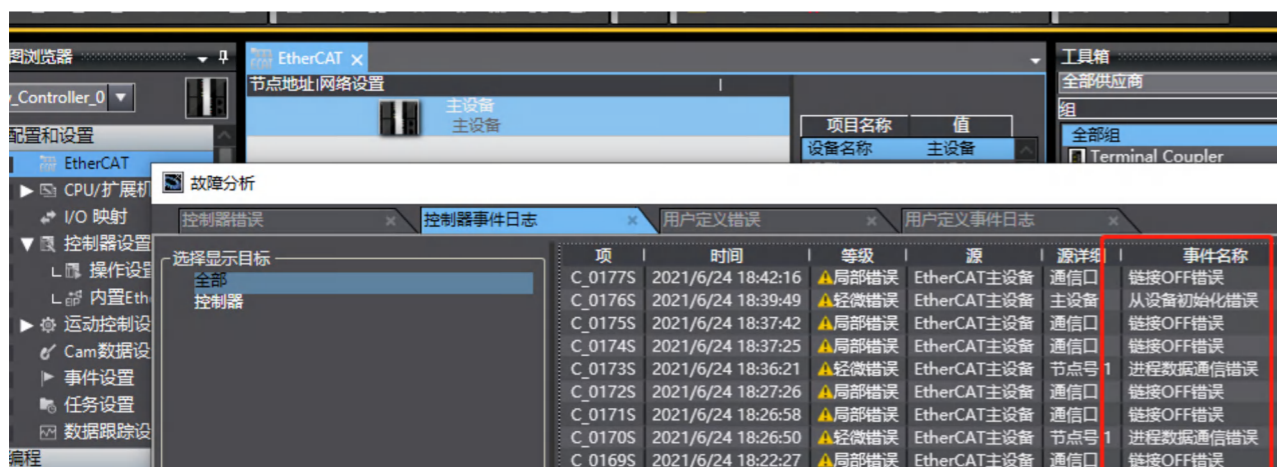





**Headquarters**  
**China Leadshine Technology Co., Ltd.**

☎ +86 755 26411692    📠 +86 755 26402718  
🌐 [www.leadshine.com](http://www.leadshine.com)  
✉ [sales@leadshine.com](mailto:sales@leadshine.com) (Sales)  
    [tech@leadshine.com](mailto:tech@leadshine.com) (Technical Support)  
📍 15-20/F, Block B, Nanshan i-Valley, Shuguang Community, Xili  
Town, Nanshan District, Shenzhen 518055, China

**North America Office**  
**Leadshine America, Inc.**

☎ 1-949-608-7270    📠 1-949-638-7298  
🌐 [www.leadshineusa.com](http://www.leadshineusa.com)  
✉ [sales@leadshineusa.com](mailto:sales@leadshineusa.com) (Sales)  
    [support@leadshineusa.com](mailto:support@leadshineusa.com) (Technical Support)  
📍 26050 Towne Centre Dr.Foothill Ranch, CA 92610 USA

