

# DMC5400 4-axis Servo/Stepper Motor Motion Control Card based on PCI BUS

## Software Manual

Version 1.0

---

## CONTENTS

<b>Chapter 1 Introduction</b> .....	1
1.1 Outlines .....	1
1.2 Feature .....	1
1.3 Software Driver Installation.....	1
<b>Chapter 2 Operation Principle and functions</b> .....	2
2.1 Pulse output mode.....	2
2.2 Preset mode .....	2
2.3 Continuous motion mode.....	3
2.4 Trapezoidal motion mode.....	3
2.5 S-curve motion mode .....	4
2.6 Interpolation motion mode.....	4
2.7 Home mode .....	5
2.8 Pulser input mode.....	6
<b>Chapter 3 Function Description</b> .....	7
3.1 List of Functions.....	7
3.2 Initialization and configuration functions .....	9
3.3 Pulse Input/Output configuration.....	9
3.4 Velocity setting.....	10
3.5 Single axis position motion.....	13
3.6 Multi-axis Linear Interpolation Motion.....	15
3.7 2-axis Circular Interpolation motion.....	16
3.8 Home return.....	17
3.9 Manual pulsar motion.....	17
3.10 Motion status & Motion Interface I/O.....	18
3.11 Motion interface I/O.....	20
3.12 Encoder position & internal counter control.....	23
3.13 Software limitation .....	24
3.14 Latch function and register control .....	25
3.15 General-purpose Input/output control.....	26
3.16 Interrupt control.....	27



# Chapter 1 Introduction

## 1.1 Outlines

DMC5400 motion control card is characteristic of high performance base on PCI bus, which can drive total 4 axes stepper or servo motor.

## 1.2 Feature

- 2 axis motion
- 4 axes of step and direction pulse output for controlling stepper or servo motor
- Maximum output frequency of 6.55 MPPS
- Pulse output options: OUT/DIR, CW/CCW
- Any 2-4 of 4 axes linear interpolation
- Any 2 of 4 axes circular interpolation
- Manual pulse input interface
- Continuous interpolation for contour following motion
- Change target and speed on the fly
- 13 home return modes with auto searching
- 2 software end-limits for each axis
- Home switch, index signal (EZ), positive, and negative end limit switches interface on all axes
- 4-axis high speed position latch input
- Programmable interrupt sources
- Simultaneous start/stop function
- Total 5 cards can be used in one computer (software support more )
- DMC5400 libraries for DOS and Window98/2000/XP
- DMC5400 libraries for VC++ or VB

## 1.3 Software Driver Installation

Software installation steps:

(1) Insert LAKESIDE installation CD, chose DMC5400 directory, run the MotionInstall.exe, follow the procedures of the installer.

(2) After complete the installation, reboot you computer.

**Note:** If you need to install the driver in DOS system, please find the function library , and copy to you development directory.

## Chapter 2 Operation Principle and functions

### 2.1 Pulse output mode

The pulse output of DMC5400 has two mode : (1) PUL + DIR mode (single pulse output mode); (2) CW/CCW type pulse output mode (dual pulse output mode).

In PUL + DIR mode, see the figure 2-1 :

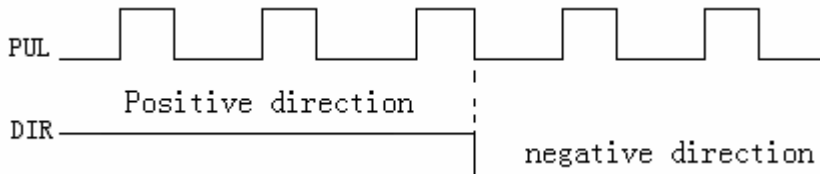

Fig.2-1 PUL + DIR mode

In CW/CCW mode, see the figure 2-2:

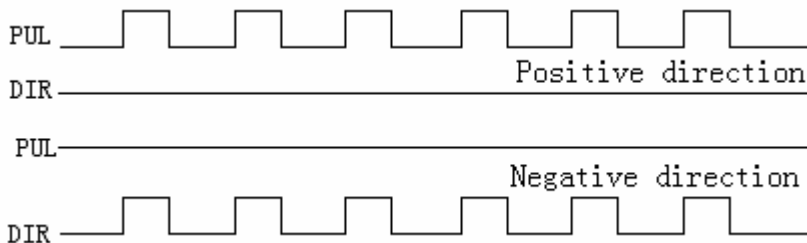

Fig.2-2 CW/CCW mode

Relative function :

d5400\_set\_pulse\_outmode(WORD axis, WORD outmode)

### 2.2 Preset mode

In this mode, the CPU will send a number of pulses to the card, and configure the acceleration、deceleration and speed, after that, the card will automatically arrange it to drive the motor. When the output pulse equal to the preset pulse, the card will stop output pulse. This mode shows as figure 2-3:

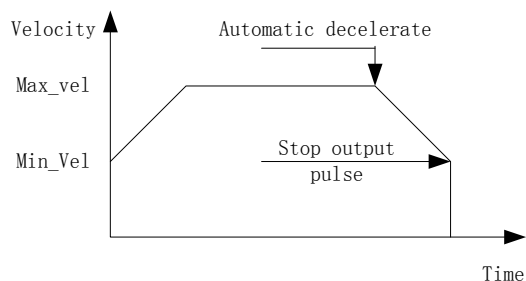

Fig.2-3 Preset mode

Relative functions:

d5400\_t\_pmove(WORD axis, long Dist, WORD posi\_mode )

d5400\_ex\_t\_pmove(WORD axis, long Dist, WORD posi\_mode)



## 2.3 Continuous motion mode

In this mode, the motion start on starting speed, then accelerate to operating speed, and decelerate stop when it accept the stop command or extern stop signal. In trapezoidal continuous motion mode, when the decelerate to stop command input, the velocity decelerates from Max\_vel to Min\_vel, and then stop output pulse, it shows as figure 2-4:

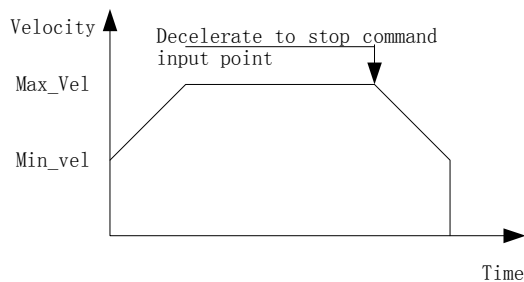

Fig.2-4 Continuous motion mode

Relative functions:

d5400\_t\_vmove(WORD axis, WORD dir)

d5400\_s\_vmove(WORD axis, WORD dir)

## 2.4 Trapezoidal motion mode

In this mode, single axis is moved to a specified position (or distance) with a trapezoidal velocity profile. The motor starts motion on starting speed, then accelerate to operating speed, and stop after decelerate to starting speed. User can set the motion distance (total output pulse number).

This mode shows as figure 2-5:

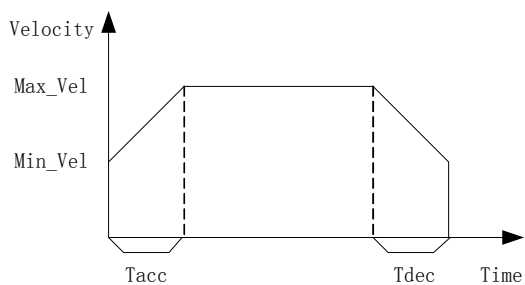

Fig.2-5 Continuous motion mode

Relative functions:

d5400\_set\_profile(WORD axis, double Min\_Vel, double Max\_Vel, double Tacc, double Tdec)

d5400\_t\_pmove(WORD axis, long Dist, WORD posi\_mode)

d5400\_ex\_t\_pmove(WORD axis, long Dist, WORD posi\_mode)

d5400\_t\_vmove(WORD axis, WORD dir)

d5400\_t\_line2(WORD axis1, long Dist1, WORD axis2, long Dist2, WORD posi\_mode)



d5400\_t\_line3(WORD \*axis, long Dist1, long Dist2, long Dist3, WORD posi\_mode)

d5400\_t\_line4(WORD cardno, long Dist1, long Dist2, long Dist3, long Dist4, WORD posi\_mode)

## 2.5 S-curve motion mode

In this mode, single axis is moved to a specified position (or distance) with a S-curve velocity profile. The S-curve profile is helpful for reducing the vibration of motion.

This mode shows as figure 2-6:

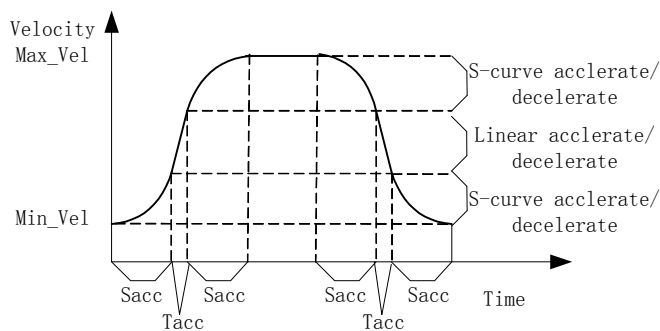

Fig.2-6 S-curve motion mode

Relative functions:

d5400\_set\_s\_profile(WORD axis, double Min\_Vel, double Max\_Vel, double Tacc, long Sacc)

d5400\_s\_pmove(WORD axis, long Dist, WORD posi\_mode)

d5400\_s\_vmove(WORD axis, WORD dir)

## 2.6 Interpolation motion mode

In this mode, the card can perform any 2-4 axes of the 4 axes linear interpolation, or any 2 of the 4 axes circular interpolation.

(1) Linear interpolation

Any 2-4 axes of the 4 axes can be used in the linear interpolation mode.

(2) Circular interpolation

Any 2 of the 4 axes of the card can perform circular interpolation. The motion start from the current position, and move to a specified position according to the configured value of center point、end point、direction (either CW or CCW).

(3) Constance speed mode

In this mode, the constant speed function makes the motion speed no change when the interpolated axes change.

(4) Continuous interpolation motion mode

Continuous interpolation includes linear interpolation and circular interpolation. In this mode, the card keeps on output the continuous pulse.

Relative functions:

d5400\_t\_line2(WORD axis1, long Dist1, WORD axis2, long Dist2, WORD posi\_mode)

d5400\_t\_line3(WORD \*axis, long Dist1, long Dist2, long Dist3, WORD posi\_mode)

d5400\_t\_line4(WORD cardno, long Dist1, long Dist2, long Dist3, long Dist4, WORD posi\_mode)

d5400\_arc\_move(WORD \*axis, long \*target\_pos, long \*cen\_pos, WORD arc\_dir)

d5400\_pre\_arc\_move(WORD \*axis, long \*star\_pos, long \*target\_pos, long \*cen\_pos, WORD arc\_dir)

## 2.7 Home mode

In this mode, each axis can use two operated mode to return home or find the origin point.

(1) Accelerate/decelerate continuous mode that is usually applies on high-speed home return or finding origin point.

Only ORG signal, no index signal. The ORG signal makes the card decelerate to starting speed and then stops PUL and DIR pins from outputting pulses to complete the origin return. It shows as figure 2-7:

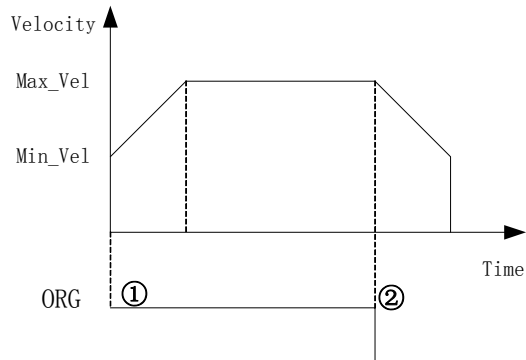

Fig.2-7 Accelerate/decelerate continuous mode

(2) Constant speed continuous mode that is usually applies on low-speed home return or finding origin point.

Only ORG signal, no index signal. The ORG signal makes the card stops PUL and DIR pins from outputting pulses to complete the origin return. It shows as figure 2-8:

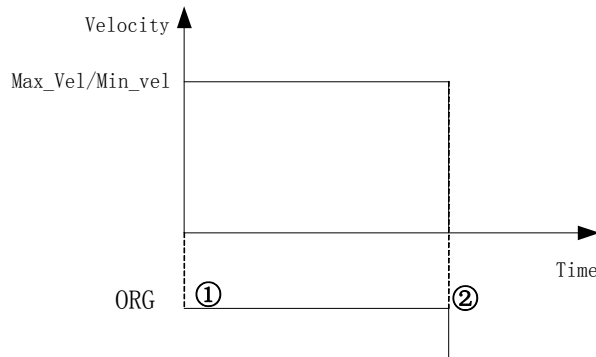

Fig.2-8 Constant speed continuous mode

Relative function:

d5400\_t\_line2(WORD axis1,long Dist1,WORD axis2,long Dist2,WORD posi\_mode)

d5400\_t\_line3(WORD \*axis, long Dist1,long Dist2,long Dist3,WORD posi\_mode)

d5400\_t\_line4(WORD cardno, long Dist1,long Dist2,long Dist3,long Dist4,WORD posi\_mode)

d5400\_arc\_move(WORD \*axis, long \*target\_pos, long \*cen\_pos, WORD arc\_dir)

d5400\_pre\_arc\_move(WORD \*axis, long \*star\_pos, long \*target\_pos, long \*cen\_pos, WORD arc\_dir)



## 2.8 Pulser input mode

The DMC5400 can accept the input pulser signals from the X3 connector, and the input signals guide the motor to follow.

Relative function:

d5400\_set\_handwheel\_inmode(WORD axis, WORD inmode, WORD count\_dir)

d5400\_handwheel\_move(WORD axis, double vh)

d5400\_set\_handwheel\_pulse(WORD axis, long hPulse)





## Chapter 3 Function Description

### 3.1 List of Functions

Initialization functions ( section 3.2 )

d5400_board_init	Initialize board
d5400_board_close	Close board

Pulse input/output configuration ( section 3.3 )

d5400_set_pulse_outmode	Set pulse output mode
d5400_set_pulse_inmode	Set pulse input mode

Velocity setting ( section 3.4 )

d5400_set_s_profile	Set S-curve velocity
d5400_set_profile	Set T-curve velocity
d5400_set_vector_profile	Set vector velocity for multi-axis
d5400_change_speed	Change velocity on the fly
d5400_read_current_speed	Read current velocity
d5400_variety_speed_range	Set velocity range
d5400_decel_stop	Decelerate to stop
d5400_imd_stop	Immediately stop
d5400_simultaneous_stop	Simultaneously stop
d5400_emg_stop	Emergency stop

Single axis position motion ( section 3.5 )

d5400_t_pmove	Single axis T-curve position move ( symmetrical T-curve acceleration and deceleration )
d5400_ex_t_pmove	Single axis T-curve position move ( asymmetrical T-curve acceleration and deceleration )
d5400_s_pmove	Single axis S-curve position move ( symmetrical S-curve acceleration and deceleration )
d5400_t_vmove	Single axis T-curve continuous move
d5400_s_vmove	Single axis S-curve continuous move

Multi-axis Linear Interpolation Motion ( section 3.6 )

d5400_t_line2	2-axis linear interpolation for any 2 axes with symmetric t-curve profile
d5400_t_line3	3-axis linear interpolation for any 3 axes with symmetric t-curve profile
d5400_t_line4	4-axis linear interpolation for a card with symmetric t-curve profile

2-axis Circular Interpolation motion ( section 3.7 )

d5400_arc_move	Absolute circular interpolation for any 2 axes of 4 axes
d5400_rel_arc_move	Relative circular interpolation for any 2 axes of 4 axes



Home return ( section 3.8 )

d5400_config_home_mode	Configure home mode
d5400_home_move	Start a home return move

Manual pulsar motion ( section 3.9 )

d5400_set_handwheel_inmode	Set input mode of hand wheel
d5400_get_handwheel_pulse	Get hand wheel pulses
d5400_handwheel_move	Start a hand wheel move

Motion status & motion interface I/O ( section 3.10 )

d5400_check_done	Get status of current motion
d5400_get_rsts	Get status of external signals
d5400_axis_io_status	Get status of Motion interface I/O

Motion interface I/O ( section 3.11 )

d5400_config_SD_PIN	Configure SD pin
d5400_config_PCS_PIN	Configure PCS pin
d5400_config_INP_PIN	Configure INP pin
d5400_config_ERC_PIN	Configure ERC pin
d5400_config_ALM_PIN	Configure ALM pin
d5400_config_LTC_PIN	Configure LTC pin
d5400_config_CUN_CLR	Configure counter reset pin
d5400_config_EL_MODE	Configure EL pin
d5400_set_HOME_pin_logic	Configure HOME pin

Encoder position & internal counter control ( section 3.12 )

d5400_get_position	Get current internal position
d5400_set_position	Set new position
d5400_get_encoder	Get external encoder position
d5400_set_encoder	Set new encoder position
d5400_reset_target_position	Change target position on the fly
d5400_get_position_deviation	Get position deviation
d5400_cls_position_deviation	Clear position deviation

Software limitation ( section 3.13 )

d5400_config_softlimit	Configure software limitation
d5400_enable_softlimit	Enable software limitation
d5400_set_softlimit_data	Set the value of software limitation

Latch function and register control ( section 3.14 )

d5400_prebuff_status	Get the status of pre-buffer
d5400_set_latch_trigger_source	Set the trigger source of position latch
d5400_get_rcun_latch_value	Get the value of position latch



General-purpose Input/output control ( section 3.15 )

d5400_read_inbit	Get the status of input pin
d5400_write_outbit	Set the status of output pin
d5400_read_outbit	Get the status of output pin
d5400_read_inport	Get the status of input port
d5400_read_outport	Get the status of output port

Interrupt control ( section 3.16)

d5400_set_int_enable	Enable the specified card interrupt
d5400_set_int_disable	Disable the specified card interrupt
d5400_set_int_factor	Set the interrupt factor
d5400_read_event_int_factor	Get the interrupt factor
d5400_read_error_int_factor	Get the interrupt error event

### 3.2 Initialization and configuration functions

**DMC5400\_API WORD WINAPI d5400\_board\_init(void)**——initialize card

Description: allocate system resource to the card, and initialize it. Maximum up to 5 cards can be supported.

Argument: void

Return value: Total number of DMC5400 board , 0 - 5 (if no board ,return 0)

example:

```
int CardNo=d5400_board_init();
if(CardNo==0)
{
    printf("\n no DMC5400 card was found")
    getch();
    return();
}
```

**DMC5400\_API WORD WINAPI d5400\_board\_close(void)**——close board

Description: close DMC5400 card and release the pc's resource. The function must be called at the end of an application. And it performs a reversed procedure compared to d5400\_board\_init.

Argument: void

Return value: null

### 3.3 Pulse Input/Output configuration

**DMC5400\_API void WINAPI d5400\_set\_pulse\_outmode(WORD axis, WORD outmode)**——Set pulse output mode

Description: set pulse output mode of specified axis.(Attention: The output mode selected must match the related hardware



configuration of the card, or will lead to undesired results. The hardware configuration related to pulse output mode, please refer to hardware manual in detailed.)

Argument:

Axis: specify axis number.

Outmode: see below

Outmode	Positive pulse		Negative pulse	
	OUT pin	DIR pin	OUTpin	DIR pin
0		High level		Low level
1		High level		Low level
2		Low level		High level
3		Low level		High level
4		High level	High level	
5		Low level	Low level	

Return code: null

**DMC5400\_API void WINAPI d5400\_set\_pulse\_inmode(WORD axis, WORD inmode, WORD count\_dir)** —— Set pulse input mode

Description: set pulse input mode of encoders, and counting direction of counters.

Argument:

Axis: specify axis number.

Inmode: specify the input mode, see below

0—A、B phase input, 1×A/B

1—A、B phase input, 2×A/B

2—A、B phase input, 4×A/B

3— differential signal

Count\_dir: Specify the counting direction of counters, see below

0—EA/EB input counting direction(default)

1—inverse direction to the default

Return value: null

### 3.4 Velocity setting

**DMC5400\_API void WINAPI d5400\_set\_profile(WORD axis, double Min\_Vel, double Max\_Vel, double Tacc, double Tdec)**—— setting of T-curve driving velocity

Description: set the driving speed for each axis independently.

Argument:

Axis: specify axis number.

Min\_Vel: starting velocity, unit: pulse / second



Max\_Vel: maximum velocity, unit: pulse / second

Tacc: specify the whole acceleration time, unit: second

Tdec specify the whole deceleration time, unit: second

Return value: null

**DMC5400\_API void WINAPI d5400\_set\_s\_profile(WORD axis, double Min\_Vel, double Max\_Vel, double Tacc, long Sacc)**——setting of S-curve driving velocity

Description: set the driving speed for each axis independently.

Argument:

Axis: specify axis number.

Min\_Vel: starting velocity, unit: pulse / second

Max\_Vel: maximum velocity, unit: pulse / second

Tacc: specify the whole acceleration time, unit: second

Tdec specify the whole deceleration time, unit: second

Sacc: specify the S-curve acceleration pulses in the whole acceleration time, unit: pulse

Return value: null

**DMC5400\_API void WINAPI d5400\_set\_vector\_profile(double Min\_Vel, double Max\_Vel, double Tacc, double Tdec)**——set vector velocity for multi-axis

Description: The function is used to set a synthetical velocity for a multi-axis motion.

Argument:

Axis: specify axis number.

Min\_Vel: starting velocity, unit: pulse / second

Max\_Vel: maximum velocity, unit: pulse / second

Tacc: specify the whole acceleration time, unit: second

Tdec: specify the whole deceleration time, unit: second

Return value: null

**DMC5400\_API void WINAPI d5400\_change\_speed(WORD axis, double Curr\_Vel)**——change velocity on the fly

Description: the function changes the moving velocity of the specified axis, and the axis will move in new velocity immediately. (Note: Before use this function, function d5400\_variety\_speed\_range must be called to set the maximum value of variable velocity.)

Argument:

Axis: specify axis number.

Curr\_Vel: new velocity profile to set

Return value: null

**DMC5400\_API double WINAPI d5400\_read\_current\_speed(WORD axis)**——Read current velocity

Description: the function is used to read the current output frequency of a specified axis. It is applicable in any time in any operating mode.

Argument:

---



Axis: specify axis number.

Return value: null

**DMC5400\_API void WINAPI d5400\_variety\_speed\_range(WORD axis, WORD chg\_enable, double Max\_Vel)**——

Set velocity range

Description: the function changes the range of moving velocity of the specified axis when needing to change velocity.

Argument:

Axis: specify axis number.

Chg\_enable: 1 for enable, 0 for disable to change moving velocity

Max\_Vel: set the range of new velocity

Return value: null

**DMC5400\_API void WINAPI d5400\_decel\_stop(WORD axis, double Tdec)**—— Decelerate to stop

Description: the function is used to decelerate a specified axis to stop.

Argument:

Axis: specify axis number.

Tdec: deceleration time

Return value: null

**DMC5400\_API void WINAPI d5400\_imd\_stop(WORD axis)**——Immediately stop

Description: the function is used to immediately stop a specified axis.

Argument:

Axis: specify axis number.

Return value: null

**DMC5400\_API void WINAPI d5400\_simultaneous\_stop(WORD axis)**——Simultaneously stop

Description: the function is used to simultaneously decelerate a axis to stop when there is a signal on its  $\overline{STP}$  pin, and If the  $\overline{STP}$  pin of multi- axis connected together, then all these axes will decelerate to stop. (Note: the stop signal must meet a restrictor that can trigger.)

Argument:

Axis: specify axis number.

Return value: null

**DMC5400\_API void WINAPI d5400\_emg\_stop(void)**——Emergency stop

Description: The function is used to stop all axes emergency.

Argument: void

Return value: null



### 3.5 Single axis position motion

**DMC5400\_API void WINAPI d5400\_t\_pmove(WORD axis, long Dist, WORD posi\_mode)**——Single axis T-curve position move ( symmetrical T-curve acceleration and deceleration )

Description: the function is used to accelerate an axis from the starting velocity to the constant velocity and decelerates it to stop at a specified distance with a symmetric trapezoidal profile. When posi\_mode is set to 0, the axis will travel a relative distance specified by Dist, its direction is determined by the sign of Dist; when set to 1, the axis will travel to an absolute position specified by Dist, the direction is determined by the difference of Dist and current position.

Argument:

Axis: specify axis number.

Dist: target position, relative or absolute. Unit: pulse

Posi\_mode: Specify the mode of the target position, 0 – relative, 1 – absolute

Return value: null

**DMC5400\_API void WINAPI d5400\_ex\_t\_pmove(WORD axis, long Dist, WORD posi\_mode)**——Single axis T-curve position move ( asymmetrical T-curve acceleration and deceleration )

Description: the function is used to accelerate an axis from a starting velocity to the constant velocity and decelerates it to stop at a specified distance with an asymmetric trapezoidal profile. When posi\_mode is set to 0, the axis will travel a relative distance specified by Dist, its direction is determined by the sign of Dist; when set to 1, the axis will travel to an absolute position specified by Dist, the direction is determined by the error of Dist and current position.

Argument:

Axis: specify axis number.

Dist: target position, relative or absolute. Unit: pulse

Posi\_mode: specify the mode of the target position, 0 – relative, 1 – absolute

Return value: null

**DMC5400\_API void WINAPI d5400\_s\_pmove(WORD axis, long Dist, WORD posi\_mode)**——Single axis S-curve position move ( symmetrical S-curve acceleration and deceleration )

Description: the function is used to accelerate an axis from a starting velocity to the constant velocity and decelerates it to stop at a specified distance with a symmetric S-curve profile. When posi\_mode is set to 0, the axis will travel a relative distance specified by Dist, its direction is determined by the sign of Dist; when set to 1, the axis will travel to an absolute position specified by Dist, the direction is determined by the difference of Dist and current position.

Argument:

Axis: specify axis number.

Dist: target position, relative or absolute. Unit: pulse

Posi\_mode: specify the mode of the target position, 0 – relative, 1 – absolute

Return value: null

It can be seen from the following illustration, S-curve acceleration interval (Sacc) is indicated, its max value is  $(Max\_Vel + Min\_Vel) * Tacc / 2$ ; if Sacc is greater than or equal to the max value, then there is no trapezoidal acceleration interval. In this function, the interval of acceleration and deceleration process is symmetric.

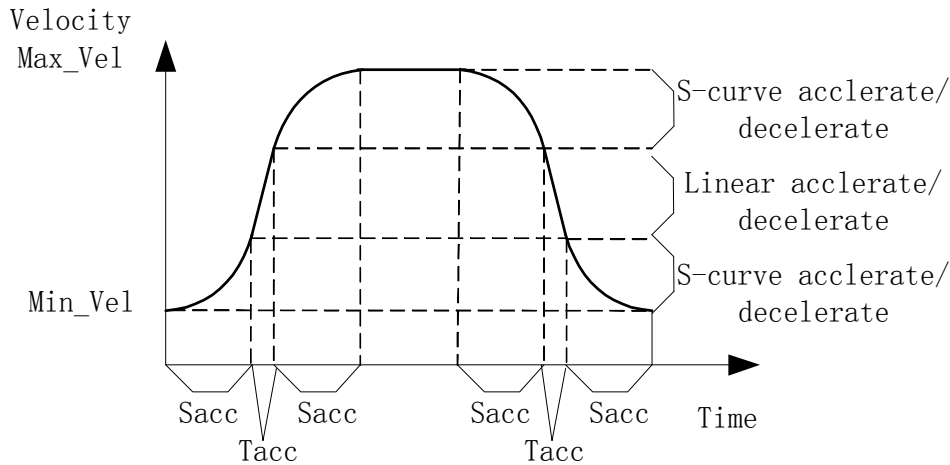

**DMC5400\_API void WINAPI d5400\_ex\_s\_pmove(WORD axis, long Dist, WORD posi\_mode)**——Single axis S-curve position move ( asymmetrical T-curve acceleration and deceleration )

Description: the function is used to accelerate an axis from a starting velocity to the constant velocity and decelerates it to stop at a specified distance with an asymmetric S-curve profile. When posi\_mode is set to 0, the axis will travel a relative distance specified by Dist, its direction is determined by the sign of Dist; when set to 1, the axis will travel to an absolute position specified by Dist, the direction is determined by the error of Dist and current position., the interval of acceleration and deceleration process can be set by Function d5400\_set\_s\_profile.

Argument:

Axis: specify axis number.

Dist: target position, relative or absolute. Unit: pulse

Posi\_mode: Specify the mode of the target position, 0 – relative, 1 – absolute

Return value: null

**DMC5400\_API void WINAPI d5400\_t\_vmmove(WORD axis, WORD dir)**——Single axis T-curve continuous move

Description: the function is used to accelerate an axis to the specified constant speed with a trapezoidal profile, and then the axis will travel at the constant velocity until the velocity is changed or the axis is commanded to stop. The direction is determined by dir parameter.

Argument:

Axis: Specify axis number.

Dir: Specify the direction of the action, 0 – negative direction, 1 – positive direction

Return value: null

**DMC5400\_API void WINAPI d5400\_s\_vmmove(WORD axis, WORD dir)**——Single axis S-curve continuous move

Description: the function is used to accelerate an axis to the specified constant speed with a S-curve profile, then the axis will travel at the constant velocity until the velocity is changed or the axis is commanded to stop. The direction is determined by dir parameter.

Argument:

Axis: specify axis number.

Dir: specify the direction of the action, 0 – negative direction, 1 – positive direction





Return value: null

### 3.6 Multi-axis Linear Interpolation Motion

**DMC5400\_API void WINAPI d5400\_t\_line2(WORD axis1,long Dist1, WORD axis2,long Dist2,WORD posi\_mode)**

——2-axis linear interpolation for Any 2 axes with symmetric t-curve profile

Description: 2-axis linear interpolation for any 2 axes with a symmetric trapezoidal profile. When posi\_mode is set to 0, the axis will travel a relative distance specified by Dist1, Dist2. When it set to 1, the axis will travel to an absolute position specified by Dist1, Dist2.

Note: this function can apply continuous interpolation that next action is succeeded to a former. When continuous interpolation is applied, posi\_mode must be set to 0, i.e., relative target mode.

Argument:

Axis1,axis2: specified axes for linear interpolation

Dist1: target position of axis1, relative or absolute. Unit: pulse

Dist2: target position of axis2, relative or absolute. Unit: pulse

Posi\_mode: specify the mode of the target position, 0 – relative, 1 – absolute

Return value: null

**DMC5400\_API void WINAPI d5400\_t\_line3(WORD \*axis, long Dist1,long Dist2,long Dist3,WORD posi\_mode)**——

3-axis linear interpolation for Any 3 axes with symmetric t-curve profile

Description: 3-axis linear interpolation for any 3 axes with a symmetric trapezoidal profile. When posi\_mode is set to 0, the axis will travel a relative distance specified by Dist1, Dist2, Dist3. When it set to 1, the axis will travel to an absolute position specified by Dist1,Dist2,Dist3.

Note: this function can apply continuous interpolation that next action is succeeded to a former. When continuous interpolation is applied, posi\_mode must be set to 0, i.e., relative target mode.

Argument:

Axis: specified axes array for linear interpolation

Dist1: target position of axis[0], relative or absolute. Unit: pulse

Dist2: target position of axis[1], relative or absolute. Unit: pulse

Dist3: target position of axis[2], relative or absolute. Unit: pulse

Posi\_mode: specify the mode of the target position, 0 – relative, 1 – absolute

Return value: null

**DMC5400\_API void WINAPI d5400\_t\_line4(WORD cardno, long Dist1,long Dist2,long Dist3,long Dist4,WORD posi\_mode)** ——4-axis Relative linear interpolation for a card with symmetric t-curve profile

Description: begin a relative or absolute 4-axis linear interpolation for a card with a symmetric trapezoidal profile.

When posi\_mode is set to 0, the axes will travel a relative distance

when set to 1, the axes will travel to an absolute position

Note: This function can apply continuous interpolation that next action is succeeded to a former. When continuous interpolation is applied, posi\_mode should be set to 0, i.e., relative target mode.

Argument:

Cardno: specified card number

---



Dist1: target position of axis X, relative or absolute. Unit: pulse  
Dist2: target position of axis Y, relative or absolute. Unit: pulse  
Dist3: target position of axis Z, relative or absolute. Unit: pulse  
Dist4: target position of axis U, relative or absolute. Unit: pulse  
Posi\_mode: specify the mode of the target position, 0 – relative, 1 – absolute  
Return code: null

### 3.7 2-axis Circular Interpolation motion

**DMC5400\_API void WINAPI d5400\_arc\_move(WORD \*axis,long \*target\_pos,long \*cen\_pos, WORD arc\_dir)**——  
absolute circular interpolation for Any 2 axes

Description: an absolute 2-axis circular interpolation for any 2 axes with a trapezoidal profile. Start point of the circle is current position. Center pointer and target is specified by cen\_pos and target\_pos, which must be set absolute positions.

Argument:

Axis: specified axes array for circular interpolation  
Target\_pos: specified target position array, unit: pluse  
Cen\_pos: specified center position array, unit: pluse  
Arc\_dir: specified the direction of circular interpolation, 0 – clockwise, 1- counterclockwise  
Return value: null

**DMC5400\_API void WINAPI d5400\_rel\_arc\_move(WORD \*axis,long \*rel\_pos,long \*rel\_cen, WORD arc\_dir)**——  
relative circular interpolation for Any 2 axes

Description: a relative 2-axis circular interpolation for any 2 axes with a trapezoidal profile. Start point of the circle is current position. Center pointer and target is set to cen\_pos and target\_pos, which must be set to relative positions.

Note: This function can apply continuous interpolation that next action is succeeded to a former.

Argument:

Axis: specified axes array for circular interpolation  
Target\_pos: specified target position array, unit: pluse  
Cen\_pos: specified center position array, unit: pluse  
Arc\_dir: specified the direction of circular interpolation, 0 – clockwise, 1- counterclockwise  
Return value: null

**DMC5400\_API void WINAPI d5400\_pre\_arc\_move(WORD \*axis,long \*star\_pos,long \*target\_pos,long \*cen\_pos, WORD arc\_dir)**——absolute circular interpolation for Any 2 axes with specify start point

Description: an absolute 2-axis circular interpolation for any 2 axes with a start point. Start point of the circle is specified by star\_pos, Center pointer and target is specified by cen\_pos and target\_pos. All the positions should be absolute positions.

Argument:

Axis: specified axes array for circular interpolation  
Star\_pos: Specified start position array, unit: pluse  
Target\_pos: Specified target position array, unit: pluse  
Cen\_pos: Specified center position array, unit: pluse  
Arc\_dir: Specified the direction of circular interpolation, 0 – clockwise, 1- counterclockwise  
Return value: null

---



### 3.8 Home return

**DMC5200\_API void WINAPI d5200\_config\_home\_mode(WORD axis,WORD mode,WORD EZ\_count)**——

Configure home mode

Description: configures the home return mode. The card supports a variety of home return modes, which enable to find or locate to home position precisely and easily. This function is called to select one of the modes.

Argument:

Axis: specify axis number.

Mode: specified the mode of home return.

1—stop immediately after meeting home,

0—stop after meeting home, and left home in the counter direction, then search home in the original direction again, stop until the axis meets home again.

EZ\_count: specified the times that EZ signal occurs. It indicates the times that EZ signal occurs after finding home signal in home return process. Value range: 1 – 16.

Example: when set to 2, it means in home return process the specified axis will continue to move after finding home signal, and stop until EZ signal occurs 2 times continuously.

Return value: null

**DMC5400\_API void WINAPI d5400\_home\_move(WORD axis, WORD home\_mode, WORD vel\_mode)** ——begin a home return move

Description: a home searching move. The mode of home searching is specified by d5400\_config\_home\_mode function, the velocity is specified by d5400\_set\_profile function, and valid logic level of home signal specified by d5400\_set\_HOME\_pin\_logic function.

Argument:

Axis: specify axis number.

Home\_mode : specified motion mode of home return

1—positive direction

2—negative direction

3—positive direction left home

4—negative direction left home

Vel\_mode: Specified the velocity mode of home return

0— low speed

1— high speed. Note: In this mode when meeting the home signal, the axis will decelerate to stop.

Return value: null

### 3.9 Manual pulsar motion

**DMC5400\_API void WINAPI d5400\_set\_handwheel\_inmode(WORD axis,WORD inmode,WORD count\_dir)**——set input mode of hand wheel

---



Description: configures the input mode of hand wheel.

Argument:

Axis: axis number

Inmode: Specified the input mode of hand wheel from the PA and PB pins.

0— 1×AB phase type pulse

1— 2×AB phase type pulse

2— 4×AB phase type pulse

3— CW/CCW type pulse input

Count\_dir: specify the counting direction of counters, its value meaning as follows:

0-default PA/PB input counting direction

1-inverse direction to the default

Return value: null

**DMC5400\_API long WINAPI d5400\_get\_handwheel\_pulse(WORD axis)** ——get hand wheel pulses

Description: the function is used to get the input pulse numbers of hand wheel.

Argument:

Axis: axis number

Return value: the input pulse number of hand wheel

**DMC5400\_API void WINAPI d5400\_handwheel\_move(WORD axis, double vh)**——begin a hand wheel move

Description: Begin to move according to the input of hand wheel.

Note: when vh = 0, this axis will not move.

Argument:

Axis: axis number

vh: specified maximum velocity, unit: pulse/s

Return value: null

### 3.10 Motion status & Motion Interface I/O

**DMC5400\_API WORD WINAPI d5400\_check\_done(WORD axis)**——get status of current motion

Description: The function is used to check the status of specified axis.

Argument:

Axis: Axis number

Return value: 0 – command pulse sending

1- command motion fulfilled

**DMC5400\_API DWORD WINAPI d5400\_get\_rsts(WORD axis)**——get status of extern signals

Description: the function is used to get the status of externals signal for specified axis.

Argument:

Axis: axis number

---



Return value: a 32 bit number, see below

Bit	Signal name	Description
0~3	Null	reserved
4	DIR	The direction of output pulse(0: positive; 1: negative )
5	STA	1: the signal of simultaneously start ( STA ) is ON
6	STP	1: the signal of simultaneously stop ( STP ) is ON
7	EMG	1: the signal of emergency stop ( EMG ) is ON
8	PCS	1: the signal of PCS is ON
9	ERC	1: the signal of ERC is ON
10	EZ	1: the signal of EZ is ON
11	Null	Reserved
12	Null	Reserved
13	CLR	1: the signal of CLR is ON
14	LTC	1: the signal of external latch LTC is ON
15	SD	1: the signal of SD is ON
16	INP	1: the signal of in-position INP is ON
17~31	null	reserved

**DMC5400\_API WORD WINAPI d5400\_axis\_io\_status(WORD axis)**——get status of Motion interface I/O

Description: the function is used to get the input /output status of specified axis.

Argument:

Axis: axis number

Return value: a 16 bit number, see below

Bit	Signal name	Description
0~7	Reserved	
8	FU	1: in acceleration
9	FD	1: in deceleration
10	FC	1: moving at a constant speed
11	ALM	1: the signal of alarm ALM is ON
12	PEL	1: the signal of +EL is ON
13	MEL	1: the signal of -EL is ON
14	ORG	1: the signal of ORG is ON
15	SD	1: the signal of SD is ON

**DMC5400\_API DWORD WINAPI d5400\_read\_error\_int\_factor(WORD axis)** ——get the status of error

Description: the function is used to get the status of error caused by interruption.

Argument:

Axis: Axis number

Return value: a 12 bit number, see below

Bit	description



Bit0~ Bit4	reserved
Bit5	Interruption caused by +EL signal is ON
Bit6	Interruption caused by -EL signal is ON
Bit7	Interruption caused by ALM signal is ON
Bit8	Interruption caused by STP signal is ON
Bit9	Interruption caused by EMG signal is ON
Bit10	Interruption caused by SD signal is ON and decelerating to stop
Bit10~ Bit11	reserved

### 3.11 Motion interface I/O

**DMC5400\_API void WINAPI d5400\_config\_SD\_PIN(WORD axis,WORD enable, WORD sd\_logic,WORD sd\_mode)**

——Configure SD pin

Description: the function is used to configure the logic level and operation mode of SD signal.

Argument:

Axis: specify axis number.

Enable: enable or disable the SD signal, 0 – disable, 1- enable

Sd\_logic: setting the active logic level of SD signal, 0 – active low, 1- active high

Sd\_mode: setting the operation mode of SD signal, value meaning:

0—decelerate to low velocity FL, if SD signal is gone, then accelerate

1—latch SD signal, and decelerate to FL

2—decelerate to FL, and then stop, if SD signal is gone in the process, then accelerate.

3—latch SD signal, and decelerate to FL, then stop

Return value: Null

**DMC5400\_API void WINAPI d5400\_config\_PCS\_PIN(WORD axis, WORD enable, WORD pcs\_logic)**——

Configure PCS pin

Description: the function is used to enable or disable changing target position when the external PCS signal is active.

Argument:

Axis: specify axis number.

Enable: enable or disable the PCS signal, 0 – disable, 1- enable

Sd\_logic: setting the active logic level of PCS signal, 0 – active low, 1- active high

Return value: Null

**DMC5400\_API void WINAPI d5400\_config\_INP\_PIN(WORD axis, WORD enable, WORD inp\_logic)**——Configure

INP pin

Description: the function is used to enable or disable INP signal, and configure its active logic. INP signal is the in-position signal input from servo driver. When the signal is set active, if begin to output specified pulses, after the pulses is over, the motion state doesn't return to stop-state, until an INP signal occurs.

Argument:

Axis: specify axis number



Enable: enable or disable the INP signal, 0 – disable, 1- enable

Inp\_logic: setting the active logic level of INP signal, 0 – active low, 1- active high

Return value: null

**DMC5400\_API void WINAPI d5400\_config\_ERC\_PIN(WORD axis, WORD enable, WORD erc\_logic, WORD erc\_width, WORD erc\_off\_time)**——Configure ERC pin

Description: the function is used to configure the output mode of ERC signal. ERC is the Error-Clear signal output for servo driver. When a servo axis is immediately stopped, there's may an error in position counter. The counter error can be cleared by sending out an ERC signal.

Argument:

Axis: specify axis number.

Enable: enable or disable the ERC signal

0 — disable,

1— if there is one of EL, ALM, CEMG signal, then output an ERC signal.

2— if there is a ORG signal, then output an ERC signal.

3— when 1,2 both occurs, output an ERC signal.

Erc\_logic: Setting the active logic level of ERC signal, 0 – active low, 1- active high

Erc\_width: Setting the time length of ERC active.

0: 12us ; 1: 102us; 2: 208us; 3: 1.6ms; 4: 13ms;

5: 52ms; 6: 104ms; 7: lever output;

Erc\_off\_time: the time that timer is closed.

0: 0us; 1: 12us; 2: 1.6ms; 3: 104ms;

Note: the specification on the output width and closed time of ERC signal.

After an ERC signal of specified axis is output, the timer begins to work, in the middle of the procedure, if a next operation command is written, the operation won't start until the closed-time of the timer is over.

Return value: null

**DMC5400\_API void WINAPI d5400\_config\_ALM\_PIN(WORD axis, WORD alm\_logic, WORD alm\_action)**——Configure ALM pin

Description: the function is used to configure ALM signal. The signal is employed for servo driver.

Argument:

Axis: specify axis number.

Alm\_logic: Setting the active logic level of ALM signal, 0 – active low, 1- active high

Alm\_action: Setting the action when ALM signal occurs.

0 — immediately stop, 1— decelerate to stop

Return value: null

**DMC5400\_API void WINAPI d5400\_config\_LTC\_PIN(WORD axis, WORD enable, WORD ltc\_logic)**——Configure LTC pin

Description: the function is used to configure the operation mode of LTC signal. Current position (command or feedback of encoder ) can be latched in the register of position latch when LTC signal is active.

Argument:

Axis: specify axis number.

Enable: enable or disable the LTC signal ,0 – disable, 1- enable

Ltc\_logic: setting the trigger mode of LTC signal, 0 –up edge active, 1- down edge active

Return value: null

**DMC5400\_API void WINAPI d5400\_config\_CUN\_CLR(WORD axis, WORD trigger\_mode, WORD enable)——**  
configure CLR pin

Description: the function is used to configure CLR( counter-clear) signal, when the signal is active, all the selected counter will be cleared.

Argument:

Axis: specify axis number.

Trigger\_mode: Specify the triggered mode of CLR signal

0— triggered by falling edge

1— triggered by rising edge

2— triggered by low level

3— triggered by high level

Enable: Select counters that need to be cleared. The selection register as follows:

Counter 1- command position

Counter 2-feedback of encoder

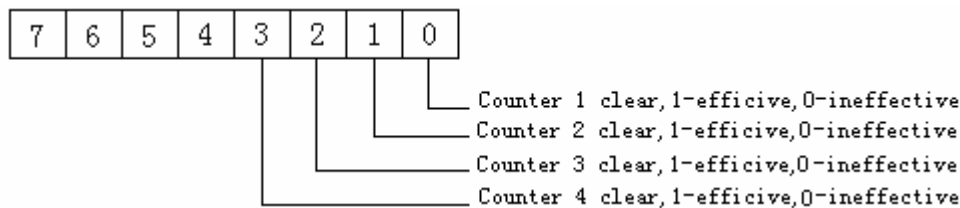

Return value: null

**DMC5400\_API void WINAPI d5400\_config\_EL\_MODE(WORD axis, WORD el\_mode) ——**configure EL pin

Description: the function is used to set the mode of EL.

Argument:

Axis: specify axis number.

el\_mode: set the reacting mode of EL signal.

0 — immediately stop, 1— decelerate to stop

Return value: null

**DMC5400\_API void WINAPI d5400\_set\_HOME\_pin\_logic(WORD axis, WORD org\_logic, WORD filter)——**  
configure ORG pin

Description: the function is used to set the active logic and filter time of ORG signal. If the filter function is enabled, the signal that its width shorter than 4 μs or equal to 4 μs will considered invalid signal, and be filtered.

Argument:

Axis: specify axis number.





Org\_logic: setting the active logic level of ORG signal, 0 – active low, 1- active high

Filter: enable or disable the filter function, 0- disable, 1-enable

Return value: null

**DMC5400\_API void WINAPI d5400\_set\_ez\_logic(WORD axis, WORD ez\_logic)**——configure EZ pin

Description: the function is used to set active logic for EZ signal of encoder.

Argument:

Axis: specify axis number.

Ez\_logic: setting the active logic level of EZ signal, 0 – active low, 1- active high

Return value: null

### 3.12 Encoder position & internal counter control

**DMC5400\_API long WINAPI d5400\_get\_position(WORD axis)**——get current internal position

Description: the function is used to read current position of specified axis.

Argument:

Axis: specify axis number.

Return value: current position, unit: pulse

**DMC5400\_API void WINAPI d5400\_set\_position(WORD axis, long current\_position)**——set new position

Description: the function is used to initiate current position counter by specified position pulse for an axis.

Argument:

Axis: specify axis number.

Current\_position: the pulse number of current position (absolute position mode)

Return value: null

**DMC5400\_API long WINAPI d5400\_get\_encoder(WORD axis)**——get external encoder position

Description: the function is used to read the counter value for encoder(mechanic position).

Argument:

Axis: specify axis number.

Return value: the counter value for encoder, unit: pulse

**DMC5400\_API void WINAPI d5400\_set\_encoder(WORD axis, long encoder\_value)**——set new encoder position

Description: the function is used to initiate the counter of encode by specified position pulse for an axis.

Argument:

Axis: specify axis number.

Current\_position: the counter value for encoder

Return value: null

**DMC5400\_API void WINAPI d5400\_reset\_target\_position(WORD axis, long dist)**——change target position on the

---



fly

Description: the function is used to change target position for specified axis during operation.

Argument:

Axis: specify axis number.

Dist: new target position

Return value: null

**DMC5400\_API long WINAPI d5400\_get\_position\_deviation(WORD axis)**——get position deviation

Description: the function is used to read the deviation between command position and position from encoder(mechanic position).

Argument:

Axis: specify axis number.

Return value: deviation value between command position and position from encoder(mechanic position)

**DMC5400\_API void WINAPI d5400\_cls\_position\_deviation(WORD axis)**——clear position deviation

Description: the function is used to clear the deviation between command position and position from encoder(mechanic position).

Argument:

Axis: specify axis number.

Return value: null

### 3.13 Software limitation

**DMC5400\_API void WINAPI d5400\_config\_softlimit(WORD axis, WORD source\_sel, WORD SL\_action)**——

configure software limitation function

Description: the function is used to set software limitation function and select a pulsar source ( internal command pulse or external pulse input from encoder) for specified axis.

Argument:

Axis: specify axis number.

Source\_sel: Selection of pulsar source 0 – command position, 1– encoder position

SL\_action: Setting the action when EL signal occurs.

0 – immediately stop, 1– decelerate to stop

Return value: null

**DMC5400\_API void WINAPI d5400\_enable\_softlimit(WORD axis, WORD ON\_OFF)**——enable software limitation function

Description: the function is used to enable or disable software limitation function for specified axis.

Argument:

Axis: specify axis number.

---



ON\_OFF: Enable or disable software limitation

0 – disable, 1– enable

Return value: null

**DMC5400\_API void WINAPI d5400\_set\_softlimit\_data(WORD axis, long N\_limit, long P\_limit)**——set the value of software limitation

Description: the function is used to set the range of software limitation function for specified axis, once software limitation is enable, motion of the axis will be limited to the range.

Argument:

Axis: specify axis number.

P\_limit: set the maximum value in positive direction

N\_limit: set the minimum value in negative direction

Return value: null

### 3.14 Latch function and register control

**DMC5400\_API WORD WINAPI d5400\_prebuff\_status(WORD axis)** ——get the status of pre-registers

Description:the function is used to check the status of pre-register for specified axis.

Argument:

Axis: Specify axis number.

Return value:

Return value	Buffer 1	Buffer 2	Buffer 3
0	empty	empty	empty
1	Not empty	empty	empty
2	Not empty	Not empty	empty
3	Not empty	Not empty	Not empty

Note: all the buffer register is empty, that also means the movement is over. i.e., in stop status.

**DMC5400\_API void WINAPI d5400\_set\_latch\_trigger\_source(WORD axis, WORD sel)**——set the trigger source of position latch

Description: the function is used to specify an external trigger source of position latch for an axis.

Argument:

Axis: specify axis number.

Sel: selection of trigger source: 0 – LTC signal active, 1- ORG signal active

Return value: null

**DMC5400\_API long WINAPI d5400\_get\_rcun\_latch\_value(WORD axis, WORD sel)**——get the value of position latch

Description: the function is used to read the position latch triggered by extern signal for specified axis.



Argument:

Axis: specify axis number.

Sel: selection of latch: 0 – command position, 1– encoder position

Return value: the value in position latch, unit: pulse

### 3.15 General-purpose Input/output control

**DMC5400\_API int WINAPI d5400\_read\_inbit(WORD bitno)**——get the status of input pin

Description: the function is used to read the status of specified input pin .

Argument:

Axis: specify axis number.

Bitno: number of general-purpose bit (1,2 ..8)

Return value: status of the pin, 1-low level, 0- high level

**DMC5400\_API void WINAPI d5400\_write\_outbit (WORD bitno,WORD on\_off)**——set the status of output pin

Description: the function is used to designate the logic level of specified output pin.

Argument:

Bitno: number of general-purpose bit (1,2 ..8)

On\_off: set the output level, 0- low level, 1-high level

Return value: null

**DMC5400\_API int WINAPI d5400\_read\_outbit(WORD bitno)**——get the status of output pin

Description: the function is used to read the status of specified output pin.

Argument:

Axis: specify axis number.

Bitno: number of general-purpose bit (1,2 ..8)

Return code: status of the pin, 0-low level, 1- high level

**DMC5400\_API long WINAPI d5400\_read\_inport(WORD card)**——get the status of input port

Description: the function is used to read the status of input port for a card. (16-bit)

Argument:

Card: specify card number.

Return value: status of input port, 16-bit unsigned value

**DMC5400\_API long WINAPI d5400\_read\_outport(WORD card)**——get the status of output port

Description: the function is used to read the status of output port for a card. (16-bit)

Argument:

Card: specify card number.

Return value: status of output port, 16-bit unsigned value



### 3.16 Interrupt control

**DMC5400\_API int WINAPI d5400\_set\_int\_enable(WORD cardno)**——enable the interrupt

Description: the function is used to enable the system interrupt event for the specified card

Argument:

Cardno: specify card number.

Return value: null

**DMC5400\_API void WINAPI d5400\_set\_int\_disable(void)**——disable the interrupt

Description: the function is used to disable the system interrupt event for the specified card

Argument: void

Return value: null

**DMC5400\_API void WINAPI d5400\_set\_int\_factor(WORD axis, DWORD int\_factor)**——set interrupt factors

Description: the function is used to select factors to initiate the event INT for the specified axis number

Argument:

Axis: specify axis number

Int\_factor: a 21-bit number, see below

Bit NO.	Description
Bit0	Normal stop
Bit1	Next command starts
Bit2	Command pre-register 2 is empty
Bit3	Reserved
Bit4	Acceleration start
Bit5	Acceleration end
Bit6	Deceleration start
Bit7	Deceleration end
Bit8	Interruption caused by EL+ signal is ON
Bit9	Interruption caused by EL- signal is ON
Bit10	Reserved
Bit11	Reserved
Bit12	Reserved
Bit13	Interruption caused by CLR signal is ON and clean the position counter
Bit14	Interruption caused by LTC signal is ON and lock the counter value
Bit15	Interruption caused by ORG signal is ON and lock the counter value
Bit16	Interruption caused by SD signal is ON
Bit17	Interruption caused by DIR signal level is change
Bit18	Interruption caused by STA signal is ON
Bit19	Reserved
Bit20	Interruption caused by stop output pulse (include: normal stop, emergency stop, etc)

Return value: null



**DMC5400\_API DWORD WINAPI d5400\_read\_event\_int\_factor(WORD axis)**——get the interrupt factors

Description: the function is used to read interrupt factors for the specified axis number

Argument:

Axis: specify axis number

Return value: a 19-bit number, see below

Bit NO.	Description
Bit0	Normal stop
Bit1	Next command starts
Bit2	Command pre-register 2 is empty
Bit3	Reserved
Bit4	Acceleration start
Bit5	Acceleration end
Bit6	Deceleration start
Bit7	Deceleration end
Bit8	Interruption caused by EL+ signal is ON
Bit9	Interruption caused by EL- signal is ON
Bit10	Reserved
Bit11	Reserved
Bit12	Reserved
Bit13	Interruption caused by CLR signal is ON and clean the position counter
Bit14	Interruption caused by LTC signal is ON and lock the counter value
Bit15	Interruption caused by ORG signal is ON and lock the counter value
Bit16	Interruption caused by SD signal is ON
Bit17	Interruption caused by DIR signal level is change
Bit18	Interruption caused by STA signal is ON

**DMC5400\_API DWORD WINAPI d5400\_read\_error\_int\_factor(WORD axis)**——Get the interrupt error event

Description: The function is used to read error events for the specified axis number

Argument:

Axis: specify axis number

Return value: 12-bit number, see below

Bit NO.	Description
Bit0~4	Reserved
Bit5	Interruption caused by EL+ signal is ON
Bit6	Interruption caused by EL- signal is ON
Bit7	Interruption caused by ALM signal is ON
Bit8	Interruption caused by STP signal is ON
Bit9	Interruption caused by EMG signal is ON
Bit10	Interruption caused by SD signal is ON
Bit11 ~ Bit31	Reserved